

**OPPO** | **PROTO**

2026



**ENJOY** a passionate  
**Life** with  
The best quality

**PRODUCT GALLERY**  
**Catalog Edition**

NEW PRODUCT IMAGES INCLUDE PRICES  
AND DETAILED PARAMETERS

# About Us

CHEN ZHANG ENTERPRISES CORPORATION is the absolute distributor of Oppo Electricals and Lighting. It was incorporated in the Philippines and registered with the Philippine Securities and Exchange Commission (SEC) on September 14, 2004. Since then it has been blessed a reputation over the years for quality lighting fixtures and wiring devices.











# Mission

The main purpose of Chen Zhang Ent. Corp is to outreach our customers' expectations in quality, delivery and cost through continuous improvement and customer service.

# Vision

To become the most successful and respected electrical company in the Philippines. And to produce more advanced electrical, wiring devices and related products.

# OUR PRODUCTS

	ACCS. / EXTENSION / DOORBELL -----	03-07
	BULB / TUBE -----	08-13
	CEILING / DOWNLIGHT / TRACK LIGHT -----	14-25
	BREAKER / DISTRIBUTION BOX -----	26-31
	PVC / TAPE / PLASTIC -----	32-39
	EXHAUST FAN / OUTLET -----	40-55
	WALL LIGHT -----	56-65
	EMERGENCY EQUIP. -----	66-73
	FLOOD LIGHT / SOLAR LIGHT -----	74-80
	STRIP LIGHT / STRING LIGHT -----	81-89
	METAL ACCS. / WIRE -----	90-98

ACCS. / EXTENSION / DOORBELL
BULB / TUBE
CEILING / DOWNLIGHT / TRACK LIGHT
BREAKER / DISTRIBUTION BOX
PVC / TAPE / PLASTIC
EXHAUST FAN / OUTLET
WALL LIGHT
EMERGENCY EQUIP.
FLOOD LIGHT / SOLAR LIGHT
STRIP LIGHT / STRING LIGHT
METAL ACCS. / WIRE



# LIGHTING ACCESSORIES



**103**  
WEATHER PROOF SOCKET  
E27  
12 PCS/PACK  
240 PCS/CTN



**114**  
CURRENT TAP SOCKET  
E27  
Keyless w/2 Flat Pin Outlet  
12 PCS/PACK  
240 PCS/CTN



**104**  
PULL CHAIN W/ SOCKET  
E27  
2 Flat Pin Outlet  
12 PCS/PACK  
240 PCS/CTN



**203**  
SOCKET PLUG  
E27 3A 250V  
12 PCS/PACK  
240 PCS/CTN



**E12-105**  
CANDELABRA SOCKET  
24 PCS/PACK  
600 PCS/CTN



**E14-105**  
CANDELABRA SOCKET  
24 PCS/PACK  
600 PCS/CTN



**106**  
RECEPTACLE (2X2)  
E27  
12 PCS/PACK  
240 PCS/CTN



**107**  
CANDELABRA SOCKET  
E27  
12 PCS/PACK  
240 PCS/CTN



**108**  
RECEPTACLE (3X3)  
E27  
12 PCS/PACK  
120 PCS/CTN



**109**  
RECEPTACLE (4X4)  
E27  
12 PCS/PACK  
120 PCS/CTN



## ALUMINUM LAMP COVER:



Description	Size(WxH)
ALC	12" 29.0x16.0 cm
	14" 33.5x16.0 cm
	16" 35.0x18.5 cm
	19" 44.0x18.0 cm

## ALUMINUM LAMP HOLDER:



**E27**



**E40**

Description	Voltage
ALH	E27 250V 6A
	E40 250V 6A

# OUTLET ACCESSORIES



ACCS. /  
EXTENSION /  
DOORBELL

## 2022

**SURFACE TYPE DOUBLE OUTLET**  
10A 250V  
12 PCS/BOX  
360 PCS/CTN



## 2033

**SURFACE TYPE 3-GANG OUTLET**  
10A 250V  
12 PCS/BOX  
360 PCS/CTN



## 2044

**SURFACE TYPE 4-GANG OUTLET**  
10A 250V  
12 PCS/BOX  
240 PCS/CTN



## WOU 102

**SPRING TYPE OUTLET**  
10A 250V  
12 PCS/PACK  
360 PCS/CTN



## WOU 103

**SPRING TYPE OUTLET**  
10A 250V  
12 PCS/PACK  
360 PCS/CTN



## 716

**HANGING SWITCH**  
3A 250V  
24 PCS/PACK  
600 PCS/CTN



## 738

**SQUARE SWITCH**  
10A 250V  
12 PCS/BOX  
600 PCS/CTN



# PLUG ACCESSORIES



## 101

**FEMALE PLUG**  
10A 250V  
24 PCS/PACK  
600 PCS/CTN



## 001

**ELECTRICAL PLUG (W/BLISTER)**  
3A 250V  
24 PCS/PACK  
600 PCS/CTN



## 001-A

**ELECTRICAL PLUG**  
3A 250V  
30 PCS/BOX  
720 PCS/CTN



## 002

**REGULAR PLUG**  
10A 250V  
24 PCS/PACK  
720 PCS/CTN



## 003

**RUBBER PLUG L.D**  
6A 250V  
24 PCS/PACK  
480 PCS/CTN



## 005

**RUBBER PLUG H.D**  
10A 250V  
24 PCS/PACK  
480 PCS/CTN



## 006

**PARALLEL GROUND RUBBER PLUG**  
15A 250V  
12 PCS/PACK  
360 PCS/CTN



## WUO 001

**CORD CONNECTION BODY-FEMALE**  
10A 250V  
24 PCS/PACK  
480 PCS/CTN



## WUO 101

**CORD CONNECTION BODY-MALE**  
10A 250V  
24 PCS/PACK  
480 PCS/CTN



## WUO 011

**REGULAR ADAPTER**  
10A 250V  
24 PCS/PACK  
480 PCS/CTN



## WUO 113

**PARALLEL GROUND PLUG**  
15A 250V  
12 PCS/PACK  
240 PCS/CTN



## WUO 113A

**PARALLEL GROUND PLUG**  
15A 250V  
12 PCS/PACK  
240 PCS/CTN



# PLUG ACCESSORIES



## WUO-004

SWING TYPE ADAPTER  
4 PLUGS 10A 250V  
24 PCS/PACK  
240 PCS/CTN



## WUO-005

SWING TYPE ADAPTER  
4 PLUGS 10A 250V  
24 PCS/PACK  
240 PCS/CTN



## WUO 002

UNIVERSAL SOCKET ADAPTER  
10A 250V  
12 PCS/PACK  
480 PCS/CTN



## WUO 003

UNIVERSAL SOCKET  
ADAPTER  
10A 250V  
12 PCS/PACK  
480 PCS/CTN



## WUS 102

UNIVERSAL SOCKET  
W/SWITCH  
10A 250V  
12 PCS/PACK  
240 PCS/CTN



## JX-63G

SCREW DRIVER  
TESTER (FLAT)  
145x15 MM  
24 PCS/BOX  
480 PCS/CTN



## CT-11

UTILITY CUTTER  
9MM (2 SPARE BLADE)  
24 PCS/BOX  
288 PCS/CTN



## CT-12

UTILITY CUTTER  
18MM (2 SPARE BLADE)  
12 PCS/BOX  
288 PCS/CTN



## CT-13

UTILITY CUTTER  
18MM (2 SPARE BLADE)  
12 PCS/BOX  
288 PCS/CTN



# DUAL PORTABLE EXTENSION



## EC-203

2 GANG  
EXTENSION 3M  
10A 250V  
60 PCS/CTN



## EC-205

2 GANG  
EXTENSION 5M  
10A 250V  
60 PCS/CTN



## EC-303

3 GANG  
EXTENSION 3M  
10A 250V  
60 PCS/CTN



## EC-305

3 GANG  
EXTENSION 5M  
10A 250V  
60 PCS/CTN



## SO-303

DUAL PORTABLE  
EXTENSION  
10A 250V  
48 PCS/CTN



## SO-305

DUAL PORTABLE  
EXTENSION  
10A 250V  
48 PCS/CTN



## SE-303

DUAL PORTABLE  
EXTENSION  
10A 250V  
48 PCS/CTN



## SE-305

DUAL PORTABLE  
EXTENSION  
10A 250V  
48 PCS/CTN



## ES-02

PUSH THROUGH  
SOCKET EXTENSION  
W/OUTLET E-27  
3A 250V  
60 PCS/CTN  
3 METER  
6 METER



## ES-03

PUSH THROUGH  
SOCKET EXTENSION E-27  
3A 250V  
60 PCS/CTN  
3 METER  
6 METER



# EXTENSION CORD

ACCS. /  
EXTENSION /  
DOORBELL



**REC-101A**  
3 WAY  
EXTENSION 1.8M  
10A 250V  
(LONGMAX.POWER  
2.500 WATTS)  
24 PCS/CTN



**REC-102A**  
4 WAY  
EXTENSION 1.8M  
10A 250V  
(LONGMAX.POWER  
2.500 WATTS)  
24 PCS/CTN



**REC-103A**  
5 WAY  
EXTENSION 1.8M  
10A 250V  
(LONGMAX.POWER  
2.500 WATTS)  
24 PCS/CTN



**REC-104A**  
4 WAY  
EXTENSION 1.8M  
10A 250V  
(LONGMAX.POWER  
2.500 WATTS)  
24 PCS/CTN



**REC-104B**  
4 WAY USB(5V=2.1A)  
EXTENSION 1.8M  
10A 250V  
(LONGMAX.POWER  
2.500 WATTS)  
24 PCS/CTN

# EXTENSION CORD FLAME RETARDANT TEMPERATURE RESISTANCE

# HEAVY DUTY EXTENSION SOCKET



**REC-101**  
3 PLUGS  
EXTENSION 2.0M  
10A 250V  
(LONGMAX.POWER  
2.500 WATTS)  
36 PCS/CTN



**REC-102**  
4 PLUGS  
EXTENSION 2.0M  
10A 250V  
(LONGMAX.POWER  
2.500 WATTS)  
36 PCS/CTN



**REC-103**  
5 PLUGS  
EXTENSION 2.0M  
10A 250V  
(LONGMAX.POWER  
2.500 WATTS)  
36 PCS/CTN



**REC-104**  
3 PLUGS  
EXTENSION 2.0M  
10A 250V  
(LONGMAX.POWER  
2.500 WATTS)  
24 PCS/CTN



**REC-105**  
4 PLUGS  
EXTENSION 2.0M  
10A 250V  
(LONGMAX.POWER  
2.500 WATTS)  
24 PCS/CTN



**REC-106**  
5 PLUGS  
EXTENSION 2.0M  
10A 250V  
(LONGMAX.POWER  
2.500 WATTS)  
24 PCS/CTN

# MECHANICAL DOORBELL

This doorbell is power-supplied by 220V current and produce melodious sound by mechanical action,telling the master a guest is coming. Press the doorbell switch a time and a Dingtone sound is produced. Don't press the doorbell continuously or no sound is produced. The sound is soft and sweet with good sustain. The doorbell with abnormal state protection function. Is a novel, practical doorbell.

**MRT162A**



Quantity 50 PCS/CTN



# SELF-GENERATING POWER WIRELESS DOORBELL



**MRT-78A**



Working frequency	433.92 MHz
Receiver rated voltage	AC 110V-220V
Receiver standby power consumption	less than 0.5W
Transmitter standby power consumption	OVA
Transmitter transmission power	less than 10mW
Controllable volume	25-85dB
Quantity	60 PCS/CTN

**MRT-78D**

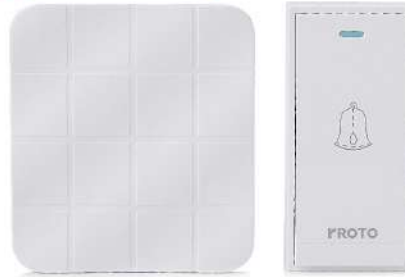

Working frequency	433.92 MHz
Receiver rated voltage	AC 110V-220V
Receiver standby power consumption	less than 0.5W
Transmitter standby power consumption	OVA
Transmitter transmission power	less than 10mW
Controllable volume	25-85dB
Quantity	60 PCS/CTN

## COLORED MINI CANDLE BULB



<b>CAP</b>	E12
<b>Energy consumption</b>	5W
<b>Input Voltage</b>	220V
<b>Quantity</b>	25 PCS/BOX 1000 PCS/CTN
<b>Color</b>	Blue \ Red \ Green\ Yellow \ Clear

## FLAME BULB



<b>CAP</b>	E12
<b>Energy consumption</b>	3W
<b>Input Voltage</b>	220V
<b>Quantity</b>	25 PCS/BOX 1000 PCS/CTN

## LED BULB

YTG45A1



<b>CAP</b>	E27
<b>Watt</b>	3W
<b>Voltage</b>	IC 150-240V
<b>P.F.</b>	0.5/0.9
<b>Lumen</b>	250
<b>Equivalent wattage</b>	32
<b>Size</b>	Φ45x80mm
<b>Quantity</b>	50 PCS/CTN
<b>Color</b>	BLUE / RED / GREEN / YELLOW

BULB /  
TUBE

## LED BULB LIGHT ENERGY A CLASS



<b>LED BULB</b>
<b>WYNN</b>
Lifetime: 15,000H
Voltage: 150-240
Cap: E27

Watt	Level	Size	Lumen	PCS/CTN
3W	2★	Φ45x 80 mm	315LM	50
5W	3★	Φ60x110mm	590LM	50
7W	3★	Φ60x110mm	826LM	50
9W	3★	Φ60x110mm	1062LM	50
12W	3★	Φ60x125mm	1416LM	50
15W	3★	Φ70x144mm	1725LM	50
20W	3★	Φ80x150mm	2300LM	40



<b>CANDLE BULB</b>
Lifetime: 25,000H
Voltage: IC 150V-240V
Size: Φ37X101MM

Watt	Level	Cap	Lumen	PCS/CTN
3W	2★	E14	300LM	50
3W	3★	E27	300LM	50



<b>LED BULB</b>
Lifetime: 25,000H
Voltage: IC 150V-240V
Cap: E27

Watt	Level	Size	Lumen	PCS/CTN
3W	3★	Φ45x 80 mm	345LM	50
5W	4★	Φ60x110mm	600LM	50
7W	4★	Φ60x110mm	840LM	50
9W	4★	Φ60x110mm	1080LM	50
12W	4★	Φ60x125mm	1440LM	50
15W	3★	Φ70x144mm	1800LM	50
20W	3★	Φ80x150mm	2400LM	40

# LED BULB LIGHT ENERGY A CLASS



BULB /  
TUBE



## LED B6

Lifetime: 25,000H  
Voltage: 150V-240V  
Cap: E27

Watt	Level	Size	Lumen	PCS/CTN
5W	3★	Φ38x 85 mm	500LM	50
7W	4★	Φ45x 95 mm	700LM	50
9W	4★	Φ45x 95 mm	900LM	50
12W	4★	Φ55x115mm	1200LM	50



## LED B2

Lifetime: 25,000H  
Voltage: IC 150V-240V  
Cap: E27

Watt	Level	Size	Lumen	PCS/CTN
15W	2★	Φ65 x125mm	1650LM	24
20W	3★	Φ80 x150mm	2200LM	24
30W	3★	Φ100x185mm	3600LM	12
40W	3★	Φ118x213mm	4800LM	12
50W	3★	Φ138x220mm	5500LM	8



## GLOBE FROSTED BULB

Lifetime: 25,000H  
Voltage: IC 150V-240V  
Cap: E27

Watt	Size	Lumen	PCS/CTN
7W	Φ80 x 120 mm	720LM	20
9W	Φ95 x 147 mm	900LM	20
12W	Φ120 x 175 mm	1050LM	20



## YTPDGL5

Lifetime: 25,000H  
Voltage: IC 170V-240V

Watt	Level	CAP	Size	Lumen	PCS/CTN
50W	3★	E27	Φ118x213mm	5500LM	20
70W	—	E27	Φ140x251mm	7700LM	12
100W	—	E40	Φ140x268mm	11000LM	8
Cover for 50W		—	—	—	20



# LED BULB LIGHT ENERGY A CLASS



Voltage: 220V~240V  
Cap: E27  
Size: Φ120X128MM  
Quantity: 24 PCS/CTN

## PAR-38

Watt	Lumen
12W	1080LM
15W	1350LM

# MOSQUITO REPELLENT LAMP



- PC yellow diffuser with mosquito repellent spectrum
- Big beam angle, uniform illumination
- Soft light without strobe, eye comfort
- High quality 2835LED chips
- Safe and reliable



Description	Watt	Voltage	Size	Lumen	PCS/CTN
YTA60E4-MR	15W	DC 12-24V	Φ60 x108mm	720LM	50
YTT80B7-MR	20W	170-240V	Φ100x180mm	1800LM	24

BULB /  
TUBE



## EMD

Voltage: 60Hz 170~240V  
Beam angle: 120°  
CRI: ≥80  
Cap: E27

# LED EMERGENCY BULB



· Adjusting brightness in three gears, Meeting the needs of different scenarios

Description	Watt	Size	Lumen	PCS/CTN
YTA60EMD	7W	Φ70x142mm	700LM	50
YTA70EMD	9W	Φ80x154mm	900LM	40
YTA80EMD	12W	Φ70x154mm	1200LM	40

# FILAMENT LIGHT



CLEAR GOLD  
YTC35Z1

Voltage: 120V / 240V  
Cap: E14  
CRI: 80  
Size: Φ35X98MM  
Quantity: 50 PCS/CTN

Watt	Lumen
3W-C	400LM
5W-C	600LM
3W-G	360LM
5W-G	540LM



CLEAR GOLD  
YTA60Z1

Voltage: 100V-240V  
Cap: E27  
CRI: 80  
Size: Φ60X109MM  
Quantity: 50 PCS/CTN

Watt	Lumen
5W-C	400LM
7W-C	600LM
5W-G	360LM
7W-G	540LM



CLEAR GOLD  
YTST64Z1

Voltage: 100V-240V  
Cap: E27  
CRI: 80  
Size: Φ64X140MM  
Quantity: 50 PCS/CTN

Watt	Lumen
5W-C	400LM
7W-C	600LM
5W-G	360LM
7W-G	540LM



CLEAR GOLD  
YTG80Z1

Voltage: 100V-240V  
Cap: E27  
CRI: 80  
Size: Φ80X116MM  
Quantity: 20 PCS/CTN

Watt	Lumen
5W-C	400LM
7W-C	600LM
5W-G	360LM
7W-G	540LM



CLEAR GOLD  
YTG95Z1

Voltage: 100V-240V  
Cap: E27  
CRI: 80  
Size: Φ95X134MM  
Quantity: 12 PCS/CTN

Watt	Lumen
5W-C	400LM
7W-C	600LM
5W-G	360LM
7W-G	540LM



CLEAR GOLD  
YTG125Z1

Voltage: 100V-240V  
Cap: E27  
CRI: 80  
Size: Φ125X172MM  
Quantity: 12 PCS/CTN

Watt	Lumen
5W-C	400LM
7W-C	600LM
5W-G	360LM
7W-G	540LM

BULB /  
TUBE



## LED T8 TUBE-GLASS

**YTT8A2**

SINGLE END/DOUBLE END

Description	Voltage	Watt	Lumen	Level	CCT Optional	Life Time	Size	Quantity
YTT8A2	IC 170-240V	9W	945LM	2★	3000-6500K	25,000Hr	589.8 x 30 x 30mm	25 PCS/CTN
YTT8A2	IC 170-240V	18W	1890LM	2★	3000-6500K	25,000Hr	1199.4 x 30 x 30mm	25 PCS/CTN
YTT8A2	IC 170-240V	20W	2000LM	2★	3000-6500K	25,000Hr	1199.4 x 30 x 30mm	25 PCS/CTN
YTT8A2	IC 170-240V	22W	2310LM	2★	3000-6500K	25,000Hr	1199.4 x 30 x 30mm	25 PCS/CTN
YTT8A2	IC 170-240V	30W	3150LM	2★	3000-6500K	25,000Hr	1199.4 x 30 x 30mm	25 PCS/CTN



## ACCESSORY: LED TUBE CLIP HOLDER

200PCS/CTN

**CS-002**

FOR SINGLE END ONLY

## LED T5 PC BATTEN **SMD4014**

PC extrusion batten with non-isolated driver, ultra-competitive on cost and safe for its design. Have unique heat-sink design in it, make the batten's temperature under limit. Uniform & soft light output, no black space connection, K Slim in size, various in length, can be mostly applied in cove or cabin, easy installation. Life reaches 30,000hrs, 6 times of traditional T5 fluorescent batten.



Description	Voltage	Watt	Lumen output	Life Time	CCT optional	Size	Quantity
SMD4014-LED 4W	110-240V	4W	300LM	25,000H	3000-6500K	290 x 24.4 x 36mm	25 PCS/CTN
SMD4014-LED 8W	110-240V	8W	650LM	25,000H	3000-6500K	530 x 24.4 x 36mm	25 PCS/CTN
SMD4014-LED 11W	110-240V	11W	900LM	25,000H	3000-6500K	830 x 24.4 x 36mm	25 PCS/CTN
SMD4014-LED 16W	110-240V	16W	1300LM	25,000H	3000-6500K	1130 x 24.4 x 36mm	25 PCS/CTN

## LED T8 TUBE BATTEN

**MBL-2021A**

DOUBLE END ONLY



Description	Voltage	Watt	Lumen	Life Time	Size	Quantity
LED 9W	110-240V	9W	945LM	25,000H	61.5 x 17 x 19.6mm	20 PCS/CTN
LED 18W	110-240V	18W	1890LM	25,000H	122.5 x 17 x 19.6mm	20 PCS/CTN

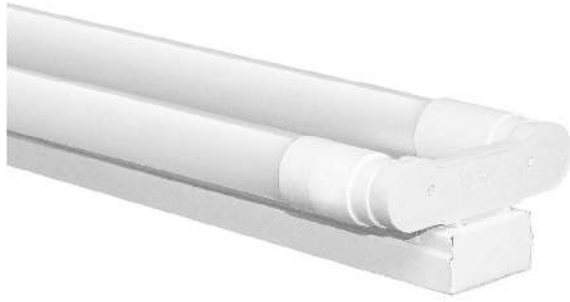

## LED T8 TUBE ALUMINUM BATTEN

**MXL-2110**

BULB/  
TUBE

Description	Voltage	Watt	Lumen	LED	P.F.	CRI	Connection Way	Size	Quantity
LED2x18W	175-240V	2x18W	3600LM	SMD2835	0.5	≥80	double-end	1230x100x53mm	20 PCS/CTN



## WALL LAMP

**XHD-12**

Description	Voltage	Watt	Lumen	CRI	Specifications	Warranty	Quantity
XHD-12	180-265V	18W	1700LM	80	0.6m	2 years	30 PCS/CTN
XHD-12	180-265V	36W	2800LM	80	1.2m	2 years	30 PCS/CTN

## AMEOBA FIXTURE DIFFUSE/CLEAR

**XHB-22**



Description	Voltage	Watt	Lumen	CRI	Specifications	Warranty	Quantity
XHB-22	180-265V	28W	2800LM	70	60 X 600 mm	2 years	30 PCS/CTN
XHB-22	180-265V	50W	4800LM	70	60 X 1200 mm	2 years	30 PCS/CTN
XHB-22	180-265V	80W	7800LM	70	75 X 1200 mm	2 years	20 PCS/CTN
XHB-22	180-265V	90W	8800LM	80	95 X 1200 mm	2 years	20 PCS/CTN
XHB-22	180-265V	100W	9500LM	80	100 X 1200 mm	2 years	20 PCS/CTN

## SUPERMARKET LIGHT

- High heat dissipation stretch aluminum bracket
- High lumens and high light efficiency
- IC driver, no strobe
- High transmittance PC cover, large luminous surface
- High quality 2835 LED chips
- Safe and reliable

**MXL-2056**



Description	Voltage	Watt	Lumen	Beam Angle	P.F.	CRI	Dimension	Lifetime	Quantity
MXL2056	170-240V	50W	4000LM	120°	0.9	≥80	600 x 108 x 53 mm	25000H	10 PCS/CTN
MXL2056	170-240V	100W	8000LM	120°	0.9	≥80	1200 x 108 x 53 mm	25000H	10 PCS/CTN

# LED RECTANGULAR HANGING LIGHT

- High lumens and high light efficiency
- High transmittance PS cover, large luminous surface
- High quality 2835 LED chips
- Safe and reliable



**MDL-1001**

**MDL-1016**

Description	Voltage	Watt	Lumen	Beam Angle	P.F:	CRI	Dimension	Lifetime	Quantity
<b>CONNECTION STYLE</b>									
LED18	170-240V	18W	1800LM	120°	0.5	≥80	613 x 50 x 45mm	30000H	20 PCS/CTN
<b>MDL-1001</b> LED36	170-240V	36W	3600LM	120°	0.9	≥80	1213 x 50 x 45mm	30000H	20 PCS/CTN
<b>NO CONNECTION STYLE</b>									
<b>MDL-1016</b> LED36	170-240V	36W	3600LM	120°	0.9	≥80	1185 x 100 x 50mm	30000H	12 PCS/CTN

# LED WATERPROOF BATTEN

**GWL1035 IP65**

- Diffuser with high transmittance diffuser, high luminous efficacy
- Vibration-proof structure design, strong Vibration-proof ability
- Solid structure with waterproof, dust proof, anti-corrosion
- Multiple installation methods, well adapt to various environments
- High quality 2835 LED chips
- IP65, IK08

**Double-ended WITH TUBE**



Description	Voltage	Watt	Diffuser	T8 Tube	Beam Angle	CRI	Size(mm)	Quantity
GWL1035	180-265V	18W	Clear	Double-ended	120°	80	1270 x W60 x H59	10 PCS/CTN
GWL1035	180-265V	36W	Clear	Double-ended	120°	80	1270 x W90 x H59	6 PCS/CTN

# INDUSTRIAL TYPE REFLECTOR



**MX803-A**

WITHOUT BALLAST  
1 X 40W  
23PCS/CTN



**MX803-B**

WITHOUT BALLAST  
2 X 40W  
13PCS/CTN

# LED MOLD LIGHT

LET THE NEW LIGHT  
ILLUMINATE THE NEW LIFE

**MXG 10**

**25000hrs**



Product of green environmental protection energy saving and high efficiency fine workmanship real materials

Watt	12W	18W	24W
Lumen	≥1080LM±5%	≥1620LM±5%	≥2160LM±5%
Size	Φ180 x H25	Φ218 x H25	Φ253 x H25
Quantity	20 PCS/CTN	20 PCS/CTN	20 PCS/CTN

CEILING /  
DOWNLIGHT /  
TRACK LIGHT

# TRI-COLOR

**MXG 10**

**25000hrs**



Product of green environmental protection energy saving and high efficiency fine workmanship real materials

Watt	12W	18W	24W
Lumen	≥1080LM±5%	≥1620LM±5%	≥2160LM±5%
Size	Φ180xH25 mm	Φ218xH25 mm	Φ253xH25 mm
Quantity	20 PCS/CTN	20 PCS/CTN	20 PCS/CTN



## LAMPSHADE

ULTRA-THIN ACRYLIC  
LED CLASSIC CEILING LAMP  
IP20/IP44

- \* Energy saving and high efficiency.
- \* Product of green environmental protection.
- \* Fine workmanship real materials



**ML-10G**



**ML-20G**

Description	Voltage	Watt	P.F:	Lumen	CRI	CCT Optional	Size	Quantity
ML 10G/20G LED 12W	170-240V	12W	0.5/0.9	420LM	≥80	3000-6500K	255x65mm	20 PCS/CTN
ML 10G/20G LED 18W	170-240V	18W	0.5/0.9	850LM	≥80	3000-6500K	335x65mm	20 PCS/CTN
ML 10G/20G LED 24W	170-240V	24W	0.5/0.9	1200LM	≥80	3000-6500K	385x65mm	20 PCS/CTN

# LED CLASSIC CEILING LAMP

MXL 1012

IP20/IP44



CEILING /  
DOWNLIGHT /  
TRACK LIGHT

Description	Voltage	Watt	P.F:	Lumen	CRI	CCT Optional	Size	Quantity
MXL 1012	170-240V	12W	0.5/0.9	550LM	≥80	3000-6500K	Φ260x90mm	10 PCS/CTN
MXL 1012	170-240V	18W	0.5/0.9	1200LM	≥80	3000-6500K	Φ340x105mm	10 PCS/CTN
MXL 1012	170-240V	24W	0.5/0.9	1700LM	≥80	3000-6500K	Φ380x105mm	10 PCS/CTN

# TRI-COLOR LED CEILING LAMP



MXD 1012

IP20/IP44



HLP 1018

IP54 Fixed ring: Multiple material colors are available



SQT 1021

IP54 Fixed ring: Multiple material colors are available

Description	Voltage	Watt	P.F:	Lumen	CRI	Size	Quantity
MXD 1012	170-260V	12W	> 0.5	≥840LM±5%	≥80	Φ277x68 mm	10 PCS/CTN
	170-260V	18W	> 0.5	≥1260LM±5%	≥80	Φ327x68 mm	10 PCS/CTN
	170-260V	24W	> 0.5	≥1680LM±5%	≥80	Φ377x68 mm	10 PCS/CTN

Description	Voltage	Watt	P.F:	Lumen	CRI	Size	Quantity
HLP 1018	170-260V	12W	> 0.5	≥840LM±5%	≥80	Φ277x68mm	10PCS/CTN
	170-260V	18W	> 0.5	≥1260LM±5%	≥80	Φ327x68mm	10PCS/CTN
	170-260V	24W	> 0.5	≥1680LM±5%	≥80	Φ377x68mm	10PCS/CTN

Description	Voltage	Watt	P.F:	Lumen	CRI	Size	Quantity
SQT 1021	175-265V	18W	≥0.5	≥1300LM±5%	≥80	300x300x65mm	10PCS/CTN
	175-265V	24W	≥0.5	≥1800LM±5%	≥80	370x370x70mm	10PCS/CTN

# CEILING LAMP

## TRI-COLOR / DIMMABLE

- Infrared sensing with remote control
- Adjustable light and color temperature

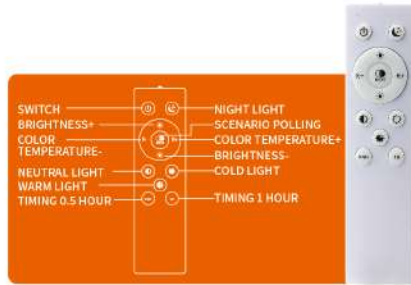

**MXL1115-PS**



**MXL1083**

CEILING /  
DOWNLIGHT /  
TRACK LIGHT

Description	Voltage	Watt	P.F:	Lumen	CRI	Beam Angle	Size	Quantity
<b>MXL1115-PS</b>	170-240V	36W	0.9	3600LM	≥80	120°	Φ350 x 43mm	10 PCS/CTN
	170-240V	50W	0.9	5000LM	≥80	120°	Φ450 x 48mm	8 PCS/CTN

Description	Voltage	Watt	P.F:	Lumen	CRI	Beam Angle	Size	Quantity
<b>MXL1083</b>	220-240V	60W	0.9	5400LM	≥80	120°	Φ530 x 80mm	4 PCS/CTN

# LED WALL LAMP

## IP65

- One-piece molding housing, simple and refined appearance
- High-quality engineering plastic housing, high strength, no yellowing
- Long lifespan
- Water resistant grade up to IP65 outdoor use available



**ZDL1177-Y**



**ZDL1177-F**

Description	Voltage	Watt	P.F:	Lumen	CRI	CCT OPTIONAL	Size	Quantity
<b>ZDL1177-Y</b>	170-240V	15W	0.5	1200LM	≥80	3000k/4000k/6500k	Φ180 x 45mm	20 PCS/CTN
	170-240V	20W	0.5	1600LM	≥80	3000k/4000k/6500k	Φ220 x 45mm	20 PCS/CTN
	170-240V	24W	0.5	2000LM	≥80	3000k/4000k/6500k	Φ280 x 60mm	10 PCS/CTN

Description	Voltage	Watt	P.F:	Lumen	CRI	CCT OPTIONAL	Size	Quantity
<b>ZDL1177-F</b>	170-240V	15W	0.5	1200LM	≥80	3000k/4000k/6500k	100 x 200 x 45mm	20 PCS/CTN
	170-240V	20W	0.5	1600LM	≥80	3000k/4000k/6500k	132 x 265 x 45mm	20 PCS/CTN

# LED DAMP-PROOF CEILING LAMP

**GWL 1002**

IP65



CEILING /  
DOWNLIGHT /  
TRACK LIGHT

Description	Voltage	Watt	P.F:	Lumen	CRI	CCT Optional	Size	Quantity
GWL 1002	170-240V	8W	0.85	550LM	≥80	3000-6500K	Φ180x80mm	10 PCS/CTN
GWL 1002	170-240V	12W	0.85	800LM	≥80	3000-6500K	Φ250x80mm	10 PCS/CTN

# LED PANEL-SIDE LIGHTING



**1035**

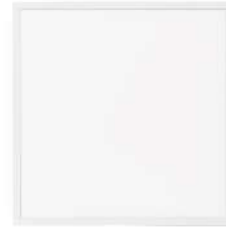

**1035**

Description	Voltage	Watt	P.F:	Lumen	CRI	CCT Optional	Size	Quantity
<b>1035</b>	170-240V	12W	0.5	1100LM	≥80	3000-6500K	300x300mm	5 PCS/CTN
	170-240V	45W	0.5	2200LM	≥80	3000-6500K	300x600mm	5 PCS/CTN
<b>1035</b>	170-240V	45W	0.9	4100LM	≥80	3000-6500K	600x600mm	6 PCS/CTN
	170-240V	45W	0.9	4100LM	≥80	3000-6500K	300x1200mm	6 PCS/CTN

# LED SPOT LIGHT

**1083**



Description	Voltage	Watt	Size	P.F:	Lumen	Ra	CCT Optional	Dimension	Open hole	Quantity
1083-A-2	220 50-60Hz	5W	2.5'	0.5	280LM	80	3000-6500K	Φ92x28mm	Φ75(75-80)mm	40 PCS/CTN
1083-A-3	220 50-60Hz	7W	3'	0.5	560LM	80	3000-6500K	Φ112x28mm	Φ95mm	40 PCS/CTN
1083-A-4	220 50-60Hz	9W	4'	0.5	720LM	80	3000-6500K	Φ138x32mm	Φ115(115-125)mm	40 PCS/CTN
1083-A-5	220 50-60Hz	12W	6'	0.5	960LM	80	3000-6500K	Φ170x32mm	Φ155(155-160)mm	40 PCS/CTN

# LED SPOT LIGHT



1241-Y



1241-F

CEILING /  
DOWNLIGHT /  
TRACK LIGHT

Description	Voltage	Watt	P.F	Lumen	Beam Angle	CCT Optional	Dimension	Open hole	Quantity	
1241-Y	3"	170-240V	5W	0.5	400LM	120°	3000-6500K	Φ90x30mm	Φ75mm	20 PCS/CTN
	3.5"	170-240V	7W	0.5	560LM	120°	3000-6500K	Φ105x30mm	Φ90mm	20 PCS/CTN
	4"	170-240V	9W	0.5	720LM	120°	3000-6500K	Φ120x30mm	Φ105mm	20 PCS/CTN
	5"	170-240V	12W	0.5	960LM	120°	3000-6500K	Φ145x30mm	Φ125mm	20 PCS/CTN
	6"	170-240V	15W	0.5	1200LM	120°	3000-6500K	Φ170x30mm	Φ150mm	20 PCS/CTN
	8"	170-240V	24W	0.5	1920LM	120°	3000-6500K	Φ225x30mm	Φ200mm	20 PCS/CTN
1241-F	5"	170-240V	12W	0.5	960LM	120°	3000-6500K	145x145x30mm	125x125mm	20 PCS/CTN
	6"	170-240V	15W	0.5	1200LM	120°	3000-6500K	170x170x30mm	150x150mm	20 PCS/CTN
	8"	170-240V	24W	0.5	1920LM	120°	3000-6500K	225x225x30mm	200x200mm	20 PCS/CTN

# MOUNTED DOWNLIGHTS

## LED RECESSED TYPE

MORE ENVIRONMENTALLY, ENERGY-SAVING



Y-A-B



F-A-B

Description	Voltage	Watt	P.F:	Lumen	CRI	CCT OPTIONAL	Size	Quantity
Y-A-B	170-240V	3W	0.5/0.9	160LM	≥80	3000-6500K	Φ90x13(2)mm	20 PCS/CTN
	170-240V	6W	0.5/0.9	360LM	≥80	3000-6500K	Φ120x13(3)mm	20 PCS/CTN
	170-240V	9W	0.5/0.9	630LM	≥80	3000-6500K	Φ145x13(4)mm	20 PCS/CTN
	170-240V	12W	0.5/0.9	840LM	≥80	3000-6500K	Φ170x13(6)mm	20 PCS/CTN
	170-240V	18W	0.5/0.9	1260LM	≥80	3000-6500K	Φ225x13(8)mm	20 PCS/CTN
	F-A-B	170-240V	3W	0.5/0.9	160LM	≥80	3000-6500K	90x90x13(2)mm
170-240V		6W	0.5/0.9	360LM	≥80	3000-6500K	120x120x13(3)mm	20 PCS/CTN
170-240V		9W	0.5/0.9	630LM	≥80	3000-6500K	145x145x13(4)mm	20 PCS/CTN
170-240V		12W	0.5/0.9	840LM	≥80	3000-6500K	170x170x13(6)mm	20 PCS/CTN
170-240V		18W	0.5/0.9	1260LM	≥80	3000-6500K	225x225x13(8)mm	20 PCS/CTN

# MOUNTED DOWNLIGHTS LED SURFACE TYPE

MORE ENVIRONMENTALLY, ENERGY-SAVING

CEILING /  
DOWNLIGHT /  
TRACK LIGHT



Y-M-B



F-M-B

Description	Voltage	Watt	P.F:	Lumen	CRI	CCT OPTIONAL	Size	Quantity
Y-M-B	170-240V	6W	0.5/0.9	360LM	≥80	3000-6500K	Φ120x34(3)mm	20 PCS/CTN
	170-240V	9W	0.5/0.9	630LM	≥80	3000-6500K	Φ145x34(4)mm	20 PCS/CTN
	170-240V	12W	0.5/0.9	840LM	≥80	3000-6500K	Φ170x34(6)mm	20 PCS/CTN
	170-240V	18W	0.5/0.9	1260LM	≥80	3000-6500K	Φ225x34(8)mm	20 PCS/CTN
F-M-B	170-240V	6W	0.5/0.9	360LM	≥80	3000-6500K	120x120x34(3)mm	20 PCS/CTN
	170-240V	9W	0.5/0.9	630LM	≥80	3000-6500K	145x145x34(4)mm	20 PCS/CTN
	170-240V	12W	0.5/0.9	840LM	≥80	3000-6500K	170x170x34(6)mm	20 PCS/CTN
	170-240V	18W	0.5/0.9	1260LM	≥80	3000-6500K	225x225x34(8)mm	20 PCS/CTN

## MOUNTED DOWNLIGHTS



1127-Y-2 IN 1

Description	Voltage	Watt	P.F:	Hole	Dimension	Lumen	CRI	Quantity
1127-Y-5W-3 inch	170-240V	5W	0.5	Ø75mm	Ø95x30mm	370LM	≥80	20 PCS/CTN
1127-Y-9W-4 inch	170-240V	9W	0.5	Ø105mm	Ø125x30mm	720LM	≥80	20 PCS/CTN
1127-Y-12W-5 inch	170-240V	12W	0.5	Ø125mm	Ø145x30mm	960LM	≥80	20 PCS/CTN
1127-Y-15W-6 inch	170-240V	15W	0.5	Ø150mm	Ø175x30mm	1200LM	≥80	20 PCS/CTN
1127-Y-24W-8 inch	170-240V	24W	0.5	Ø200mm	Ø225x30mm	1920LM	≥80	20 PCS/CTN



1127-F-2 IN 1

Description	Voltage	Watt	P.F:	Hole	Dimension	Lumen	CRI	Quantity
1127-F-9W-4 inch	170-240V	9W	0.5	105x105mm	125x1230x30mm	720LM	≥80	20 PCS/CTN
1127-F-12W-5 inch	170-240V	12W	0.5	125x125mm	145x145x30mm	960LM	≥80	20 PCS/CTN
1127-F-15W-6 inch	170-240V	15W	0.5	150x150mm	175x175x30mm	1200LM	≥80	20 PCS/CTN
1127-F-24W-8 inch	170-240V	24W	0.5	200x200mm	225x225x30mm	1920LM	≥80	20 PCS/CTN

# LED SLIM PANEL TRI-COLOR



2020-RND

2020-SQR

CEILING /  
DOWNLIGHT /  
TRACK LIGHT

Description	Voltage	Watt	P.F:	Lumen	CRI	Size	Quantity
2020-RND	100-265V	3W	>0.5	130LM+/-10%	≥80	holeØ75mm	20 PCS/CTN
	100-265V	6W	>0.5	300LM+/-10%	≥80	holeØ110mm	20 PCS/CTN
	100-265V	9W	>0.5	300LM+/-10%	≥80	holeØ135mm	20 PCS/CTN
	100-265V	12W	>0.5	720LM+/-10%	≥80	holeØ155mm	20 PCS/CTN
	100-265V	18W	>0.5	720LM+/-10%	≥80	Ø205mm	20 PCS/CTN
	100-265V	24W	>0.5	1680LM+/-10%	≥80	Ø280mm	20 PCS/CTN

Description	Voltage	Watt	P.F:	Lumen	CRI	Size	Quantity
2020-SQR	100-265V	3W	>0.5	130LM+/-10%	≥80	hole75x75mm	20 PCS/CTN
	100-265V	6W	>0.5	300LM+/-10%	≥80	hole110x110mm	20 PCS/CTN
	100-265V	9W	>0.5	300LM+/-10%	≥80	hole135x135mm	20 PCS/CTN
	100-265V	12W	>0.5	720LM+/-10%	≥80	hole155x155mm	20 PCS/CTN
	100-265V	18W	>0.5	1080LM+/-10%	≥80	205x205mm	20 PCS/CTN
	100-265V	24W	>0.5	1080LM+/-10%	≥80	280x280mm	20 PCS/CTN

# RGB TYPE SLIM PANEL

## OPTIONAL PARAMETERS

- ISOLATED DRIVER 100-265V
- PS LGP
- ALUMINUM FRAME



2030-RGB-RND

2030-RGB-SQR

Description	Voltage	Watt	P.F:	Lumen	CRI	CCT Optional	Size	Quantity
2030-RGB-RND	100-265V	3+3W	>0.5	100LM	≥80	RGB	holeØ75mm	20 PCS/CTN
	100-265V	6+3W	>0.5	240LM	≥80	RGB	holeØ105mm	20 PCS/CTN
	100-265V	12+4W	>0.5	600LM	≥80	RGB	holeØ155mm	20 PCS/CTN
	100-265V	18+6W	>0.5	900LM	≥80	RGB	Ø210mm	20 PCS/CTN

Description	Voltage	Watt	P.F:	Lumen	CRI	CCT Optional	Size	Quantity
2030-RGB-SQR	100-265V	3+3W	>0.5	100LM	≥80	RGB	hole75x75mm	20 PCS/CTN
	100-265V	6+3W	>0.5	240LM	≥80	RGB	105x105mm	20 PCS/CTN
	100-265V	12+4W	>0.5	600LM	≥80	RGB	155x155mm	20 PCS/CTN
	100-265V	18+6W	>0.5	900LM	≥80	RGB	210x210mm	20 PCS/CTN

# MOUNTED DOWNLIGHT

- Recessed installation
- High luminous flux, high luminous efficiency
- High quality 2835 LED chips
- Dimmable
- Driver built-in, integrated design
- Back light
- Safe and reliable
- Tri color

CEILING /  
DOWNLIGHT /  
TRACK LIGHT



## 1127-Y SDW—DIMMABLE



## 1127-Y SDC—TRI-COLOR



Description	Voltage	Watt	P.F:	HOLD	Dimension	Lumen	CRI	Quantity
SDW / SDC	170-240V	9W	0.5	Ø105mm	Ø125x30mm	720LM	≥80	20 PCS/CTN
SDW / SDC	170-240V	15W	0.5	Ø150mm	Ø175x30mm	1200LM	≥80	20 PCS/CTN
SDW / SDC	170-240V	24W	0.5	Ø200mm	Ø225x30mm	1920LM	≥80	20 PCS/CTN

## 1127-F SDW—DIMMABLE



## 1127-F SDC—TRI-COLOR



Description	Voltage	Watt	P.F:	HOLD	Dimension	Lumen	CRI	Quantity
SDW / SDC	170-240V	9W	0.5	105x105mm	125x125x30mm	720LM	≥80	20 PCS/CTN
SDW / SDC	170-240V	15W	0.5	150x150mm	175x175x30mm	1200LM	≥80	20 PCS/CTN
SDW / SDC	170-240V	24W	0.5	200x200mm	225x225x30mm	1920LM	≥80	20 PCS/CTN

# MOUNTED DOWNLIGHTS IP20

- Surface mount installation
- High quality LED chips, never yellowing
- Integrated IC drive
- Easy way of installing
- Safe and reliable



1033-Y

1033-Y-PS W/PIR SENSOR



Description	Voltage	Watt	P.F:	Beam angle	Dimension	Lumen	CRI	Quantity
1033-Y	170-240V	18W	0.5	120°	Ø180x25mm	1500LM	≥80	40 PCS/CTN
	170-240V	24W	0.5	120°	Ø225x25mm	2400LM	≥80	20 PCS/CTN
	170-240V	30W	0.5	120°	Ø250x25mm	3000LM	≥80	20 PCS/CTN

Description	Voltage	Watt	P.F:	Beam angle	Dimension	Lumen	CRI	Quantity
1033-Y-PS W/PIR SENSOR	170-240	18W	0.5	120°	Ø225x25mm	2400LM	≥80	20 PCS/CTN
	170-240	24W	0.5	120°	Ø250x25mm	3000LM	≥80	20 PCS/CTN

# DEEP MOUNTED DOWN LIGHT

**MXTL2001E-Y**



CEILING /  
DOWNLIGHT /  
TRACK LIGHT

Description	Voltage	Watt	P.F:	lumen us flux	CRI	Beam angle	Dimension	Quantity
MXTL2001E-Y	170-240V	5W	0.5	350LM	≥80	120°	Φ105x75mm	50 PCS/CTN
MXTL2001E-Y	170-240V	10W	0.5	700LM	≥80	120°	Φ140x75mm	40 PCS/CTN
MXTL2001E-Y	170-240V	15W	0.5	1050LM	≥80	120°	Φ180x70mm	20 PCS/CTN

# LED SPOT LIGHT



**1080**



**2050**



**2050-CL**

Description	Voltage	Watt	P.F:	Lumen	CRI	CCT Optional	Size	Quantity
<b>1080</b>	170-240V	7W	0.5/0.9	630LM	≥80	3000/6500K	Φ95x47mm	40 PCS/CTN
	170-240V	10W	0.5/0.9	900LM	≥80	3000/6500K	Φ115x48mm	40 PCS/CTN
	170-240V	20W	0.5/0.9	1800LM	≥80	3000/6500K	Φ160x60mm	40 PCS/CTN
	170-240V	30W	0.5/0.9	2700LM	≥80	3000/6500K	Φ230x72mm	12 PCS/CTN

Description	Voltage	Watt	P.F:	Lumen	CRI	CCT Optional	Size	Quantity
<b>2050</b>	IC 170-240V	3W	0.5	240LM	≥80	3000-6500K	Φ85x38mm	25 PCS/CTN
	IC 170-240V	5W	0.5	400LM	≥80	3000-6500K	Φ85x38mm	25 PCS/CTN
	IC 170-240V	7W	0.5	560LM	≥80	3000-6500K	Φ85x38mm	25 PCS/CTN

Description	Voltage	Watt	P.F:	Lumen	CRI	CCT Optional	Size	Quantity
<b>2050-CL</b>	IC 170-240V	3W	0.5	240LM	≥80	3000-6500K	Φ85x26mm	25 PCS/CTN
	IC 170-240V	5W	0.5	400LM	≥80	3000-6500K	Φ85x26mm	25 PCS/CTN
	IC 170-240V	7W	0.5	560LM	≥80	3000-6500K	Φ85x26mm	25 PCS/CTN

# BEAN GALL LAMP

- Drive built-in, integrated design
- High luminous flux, high luminous efficiency
- Back light
- High quality 2835 LED chips
- Comply with LVD, safe and reliable

CEILING /  
DOWNLIGHT /  
TRACK LIGHT



1195E



1195E-CL

Description	Watt	Voltage	P.F:	Lumen	Luminous efficacy	CRI	Size	Cut-out	Quantity
1195E	6W	170-240V	0.5	420LM	70 LM/W	80	Φ88x47mm	Φ75-80mm	20 PCS/CTN
	10W	170-240V	0.5	700LM	70 LM/W	80	Φ110x51mm	Φ90-100mm	20 PCS/CTN
	15W	170-240V	0.5	1050LM	70 LM/W	80	Φ136x55mm	Φ120-125mm	20 PCS/CTN

Description	Watt	Voltage	P.F:	Lumen	Luminous efficacy	CRI	Size	Cut-out	Quantity
1195E-CL	5W	170-240V	0.5	350LM	70 LM/W	80	Φ88x47mm	Φ75-80mm	20 PCS/CTN
	8W	170-240V	0.5	560LM	70 LM/W	80	Φ110x51mm	Φ90-100mm	20 PCS/CTN
	12W	170-240V	0.5	840LM	70 LM/W	80	Φ136x55mm	Φ120-125mm	20 PCS/CTN

# LED BULB PIN TYPE



YTMR16D4

MODEL: MR16



YTGU10D4

MODEL: GU10

Description	Watt	Voltage	P.F:	Lumen	Cap	Size	Quantity
YTMR16D4	3W	220-240V~	0.5	270LM	GU5.3	Φ50x49mm	50 PCS/CTN
	5W	220-240V~	0.5	450LM	GU5.3	Φ50x49mm	50 PCS/CTN

Description	Watt	Voltage	P.F:	Lumen	Cap	Size	Quantity
YTGU10D4	5W	220-240V~	0.5	450LM	GU10	Φ50x54mm	50 PCS/CTN
	7W	220-240V~	0.5	630LM	GU10	Φ50x54mm	50 PCS/CTN

# TRACK LIGHT FIXTURE

WHITE ○  
BLACK ●



TLF-01



TLF-02

Description	Rated voltage	CAP	Dimension	Quantity
TLF-01	85-265V 50/60Hz	GU5.3	110 x 60 x 60 mm	50 PCS/CTN
TLF-02	85-265V 50/60Hz	GU10	110 x 55 x 90 mm	50 PCS/CTN

CEILING /  
DOWNLIGHT /  
TRACK LIGHT

# WIRE CEILING BOX

WHITE ○  
BLACK ●



WCB-1



WCB-2

Description	Material	Dimension	Quantity
WCB-1	Polycarbonate	80 x 40 x 20 mm	200 PCS/CTN
WCB-2	Polycarbonate	185 x 40 x 20 mm	200 PCS/CTN



# TRACK BAR

TLB

○ WHITE  
● BLACK

Description	voltage	Material	Dimension	Quantity
TLB-10	220-240V	Aluminum	1000 x 35 x 20 mm	20 PCS/CTN
TLB-15	220-240V	Aluminum	1500 x 35 x 20 mm	20 PCS/CTN
TLB-20	220-240V	Aluminum	2000 x 35 x 20 mm	20 PCS/CTN

# TRACK LIGHT ACCESSORIES



TLA-I



TLA-L



TLA-T



TLA-X

○ WHITE  
● BLACK

Description	Material	Dimension	Quantity
TLA-I	Polycarbonate+Metal	35 x 80 x 20 mm	100 PCS/CTN
TLA-L	Polycarbonate+Metal	70 x 70 x 20 mm	100 PCS/CTN
TLA-T	Polycarbonate+Metal	70 x 100 x 20 mm	100 PCS/CTN
TLA-X	Polycarbonate+Metal	103 x 103 x 20 mm	100 PCS/CTN

# HUMAN INDUCTION DOWNLIGHT WITH SENSOR

Induction principle: Scanning moving objects and detecting the movement of heat sources.

Light sensing control: When there is strong light during the day, it does not light up. In the evening, someone walks within the sensing range, and the light is on. After leaving, the light will delay for a while and turn off.

CEILING /  
DOWNLIGHT /  
TRACK LIGHT

## MRT104-TD



<b>Model</b>	MRT104-TD
<b>Rated voltage</b>	110-250V 50Hz
<b>Rated power</b>	≤ 5W
<b>Color temperature</b>	4000K
<b>Induction angle</b>	120 °C
<b>Sensing distance</b>	2-5 meters
<b>Delay time</b>	45S
<b>Opening size</b>	90mm
<b>Installation method</b>	embedded concealed installation
<b>Quantity</b>	100 PCS/CTN



## DOWNLIGHT

- Stylish and generous
- Installation is simple and convenient
- Long life and energy saving



Description	size	Watt	Quantity
HJ2510-1	2.5"	25W	60 PCS/CTN
HJ3510-1	3.5"	25W	50 PCS/CTN
HJ4010-1	4"	40W	50 PCS/CTN
HJ5010-1	5"	40W	24 PCS/CTN
HJ2513-1	2.5"	25W	60 PCS/CTN
HJ3513-1	3.5"	25W	50 PCS/CTN
HJ4313-1	4"	40W	50 PCS/CTN
HJ5313-1	5"	40W	24 PCS/CTN

## MINIATURE BREAKER MCB DZ-SERIES



### DZG47-63-1P

12PCS/BOX 192PCS/CTN

Applicable motor capacity KW

- 16A 6KA
- 20A 6KA
- 32A 6KA
- 40A 6KA
- 63A 6KA



### DZ47-63-1P+N

12PCS/BOX 192PCS/CTN

Applicable motor capacity KW

- 10A 6KA
- 16A 6KA
- 20A 6KA
- 32A 6KA
- 40A 6KA



### DZG47-63-2P

6PCS/BOX 96PCS/CTN

Applicable motor capacity KW

- 16A 6KA
- 20A 6KA
- 32A 6KA
- 40A 6KA
- 63A 6KA



### DZG47-125-2P

4PCS/BOX 64PCS/CTN

Applicable motor capacity KW

- 80A 6KA
- 100A 6KA
- 125A 6KA

BREAKER /  
DISTRIBUTION  
BOX

## MINIATURE BREAKER MCB DZ-SERIES



### DZG47-63-3P

4PCS/BOX 64PCS/CTN

Applicable motor capacity KW

- 16A 6KA
- 20A 6KA
- 32A 6KA
- 40A 6KA
- 63A 6KA



### DZG47-125-3P

2PCS/BOX 32PCS/CTN

Applicable motor capacity KW

- 80A 6KA
- 100A 6KA
- 125A 6KA



### RHM-63-2P

6PCS/BOX 60PCS/CTN

Applicable motor capacity KW

- 16A 6KA
- 20A 6KA
- 32A 6KA
- 40A 6KA
- 63A 6KA

## MINI SAFETY BREAKER WITH COVER AND OUTLET

### DZG47-63-2P C/O

60PCS/CTN

Applicable motor capacity KW

- 16A 6KA
- 20A 6KA
- 32A 6KA



## GFCI DUPLEX UNIVERSAL OUTLET WITH GROUND

### PARAMETER DATA

- Superior lifespan
- Certified product safety
- Silver plated contacts
- Electrolytic copper components
- Oxidation resistant materials
- Corrosion resistant materials
- Solid brass contact
- Secure plug insertion
- Superior conductivity
- Enhanced contact during operation

### GFC-203

6 PCS/BOX  
60PCS/CTN



# DC MINIATURE CIRCUIT BREAKER MCB



BREAKER /  
DISTRIBUTION  
BOX

## DZG47-63-1P

250V  
12PCS/BOX 120PCS/CTN

Applicable motor  
capacity KW

- 16A 6KA
- 20A 6KA
- 32A 6KA
- 40A 6KA
- 63A 6KA

## DZG47-63-2P

500V  
6PCS/BOX 60PCS/CTN

Applicable motor  
capacity KW

- 16A 6KA
- 20A 6KA
- 32A 6KA
- 40A 6KA
- 63A 6KA

## DZG47-63-3P

750V  
4PCS/BOX 40PCS/CTN

Applicable motor  
capacity KW

- 16A 6KA
- 20A 6KA
- 32A 6KA
- 40A 6KA
- 63A 6KA

## DZG47-63-4P

1000V  
3PCS/BOX 30PCS/CTN

Applicable motor  
capacity KW

- 16A 6KA
- 20A 6KA
- 32A 6KA
- 40A 6KA
- 63A 6KA

# DC SURGE PROTECTION DEVICES MCB T2



IN 20KA — I<sub>MAX</sub> 40KA  
UCPV 600V~1500V DC



## DZG47-63-1P

600V DC  
6PCS/BOX 120PCS/CTN

Applicable motor  
capacity KW

- 40KA X 1P

## DZG47-63-2P

1000V DC  
3PCS/BOX 60PCS/CTN

Applicable motor  
capacity KW

- 40KA X 2P

## DZG47-63-3P

1500V DC  
2PCS/BOX 40PCS/CTN

Applicable motor  
capacity KW

- 40KA X 3P

## PSD

1000V  
1PC/BOX 36PCS/CTN

Applicable motor  
capacity KW

- 32A 6KA



# MOULDED CASE CIRCUIT BREAKER-MCCB EMR-250

Type	Applicable motor capacity KW	Quantity
EMR-63	MCCB 63 FRAME 3P 63A 20kA	1PC/BOX ; 20PCS/CTN
EMR-125	MCCB 125 FRAME 3P 125A 25kA	1PC/BOX ; 16PCS/CTN
EMR-250	MCCB 250 FRAME 3P 250A 35kA	1PC/BOX ; 8PCS/CTN
EMR-400	MCCB400N FRAME 3P 315A 35kA	1PC/BOX ; 4PCS/CTN
EMR-400	MCCB400N FRAME 3P 350A 35kA	1PC/BOX ; 4PCS/CTN
EMR-400	MCCB400N FRAME 3P 400A 35kA	1PC/BOX ; 4PCS/CTN
EMR-630	MCCB630N FRAME 3P 500A 35kA	1PC/BOX ; 2PCS/CTN
EMR-630	MCCB630N FRAME 3P 630A 35kA	1PC/BOX ; 2PCS/CTN
EMR-800	MCCB800N FRAME 3P 800A 35kA	1PC/BOX ; 2PCS/CTN



## CIRCUIT BREAKER

CTL-2P PLUG-IN

12 PCS/BOX  
96 PCS/CTN  
-----  
15A-20A-30A  
40A-60A  
70A  
100A



## CIRCUIT BREAKER

CTL-B-2P BOLT-ON

12 PCS/BOX  
48 PCS/CTN  
-----  
15A-20A-30A  
40A-60A  
100A



BREAKER /  
DISTRIBUTION  
BOX

## SAFETY BREAKER

SHP-2P

60 PCS/CTN  
-----  
15A-20A-30A  
40A-60A  
70A  
100A



## SAFETY BREAKER

SHP-2P-W SERIES

60 PCS/CTN  
-----  
15A-20A-30A  
40A-60A



# SLOTTED MOUNTING RAIL

HGK-01



Model	Thickness(mm)	Width(mm)	Size(mm)
HGK-01	1.0	35	1000

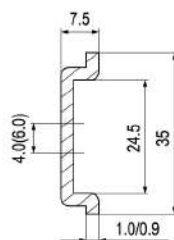
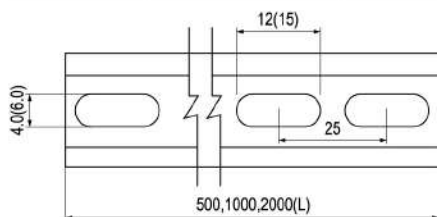

# CONNECTING TERMINAL

200 PCS/PACK

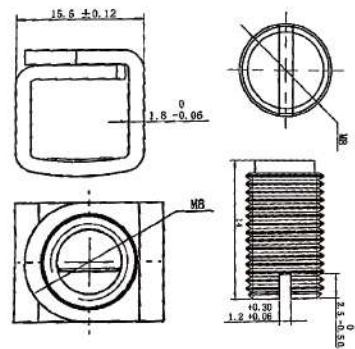

# DISTRIBUTION BOX

## SSD



Model	Type	Quantity
SSD 01	1 HOLES (2 modules)	80 PCS/CTN
SSD 01a	1 HOLES (3 modules)	50 PCS/CTN
SSD 02	2 HOLES (4 modules)	30 PCS/CTN
SSD 03	3 HOLES (6 modules)	30 PCS/CTN
SSD 04	4 HOLES (8 modules)	20 PCS/CTN
SSD 05	5 HOLES (10 modules)	12 PCS/CTN
SSD 06	6 HOLES (12 modules)	10 PCS/CTN
SSD 07	7 HOLES (15 modules)	10 PCS/CTN
SSD 09	9 HOLES (18 modules)	10 PCS/CTN
SSD 12	12 HOLES (24 modules)	10 PCS/CTN
SSD 18	18 HOLES (36 modules)	5 PCS/CTN

BREAKER /  
DISTRIBUTION  
BOX

## SDD HALF METAL

Model	Type	Quantity
SDD 02	02 HOLES (4 BIT)	30 PCS/CTN
SDD 03	03 HOLES (6 BIT)	30 PCS/CTN
SDD 04	04 HOLES (8 BIT)	20 PCS/CTN
SDD 05	05 HOLES (10 BIT)	12 PCS/CTN
SDD 06	06 HOLES (12 BIT)	10 PCS/CTN
SDD 07	07 HOLES (14 BIT)	10 PCS/CTN
SDD 09	09 HOLES (18 BIT)	10 PCS/CTN
SDD 12	12 HOLES (24 BIT)	10 PCS/CTN
SDD 14	14 HOLES (30 BIT)	5 PCS/CTN
SDD 18	18 HOLES (36 BIT)	5 PCS/CTN



## HA

- Using tight rubber rings
- Reinforced sealing ring made of polyurethane material
- High corrosion resistance
- Better waterproof and longer lifespan

Model	Sizes(mm)			Quantity
	Width	Height	Depth	
HA 4WAY	140	210	100	20 PCS/CTN
HA 8WAY	215	210	100	20 PCS/CTN
HA 12WAY	300	260	140	10 PCS/CTN
HA 18WAY	410	285	140	5 PCS/CTN
HA 24WAY	300	415	140	5 PCS/CTN
HA 26WAY	314	418	140	5 PCS/CTN
HA 36WAY	318	573	150	4 PCS/CTN
HA 54WAY	427	597	150	1 PCS/CTN

## HT

Model	Sizes(mm)			Quantity
	Width	Height	Depth	
HT-2	54	121	90	120 PCS/CTN
HT-3	79	165	95	50 PCS/CTN
HT-5	118.5	159	91.5	40 PCS/CTN
HT-8	200	154	92	30 PCS/CTN
HT-12	255	198	108	20 PCS/CTN
HT-15	309	199	109	15 PCS/CTN
HT-18	365	198	109	15 PCS/CTN
HT-24	274	356	110	10 PCS/CTN





## DISTRIBUTION BOX-SDD SK

Model	Sizes(mm)			Quantity
	Width	Height	Depth	
SK-4	107	202	100	30 /CTN
SK-6	165	200	100	20 /CTN
SK-9	219	200	100	20 /CTN
SK-12	273	230	110	20 /CTN
SK-18	381	230	115	10 /CTN
SK-24	275	380	115	10 /CTN
SK-36	380	380	116	5 /CTN

## 2 POLE PLUG-IN MPN



Size	PCS/CTN
MPN-04 4 Branches	10
MPN-06 6 Branches	10
MPN-08 8 Branches	10
MPN-10 10 Branches	10
MPN-12 12 Branches	8
MPN-14 14 Branches	8
MPN-16 16 Branches	6
MPN-18 18 Branches	6
MPN-20 20 Branches	4
MPN-22 22 Branches	4

BREAKER /  
DISTRIBUTION  
BOX

## 2 POLE BOLT-ON MPB



Model	Sizes
MPB-04	4 Branches
MPB-06	6 Branches
MPB-08	8 Branches
MPB-10	10 Branches
MPB-12	12 Branches
MPB-14	14 Branches
MPB-16	16 Branches
MPB-18	18 Branches
MPB-20	20 Branches



## NEMA 1

Sizes
2 Pole Plug-in TQL
3 Pole Plug-in TQL
2 Pole Bolt-on TQC
3 Pole Bolt-on TQC



## NEMA 3R SMALL WEATHERPROOF

Sizes	PCS/CTN
MPN-01 2 POLE BOLT-IN	20
MPB-01 2 POLE PLUG-ON	20



## DISTRIBUTION BOX DBB

Model	Sizes(H-W-L)	PCS/CTN
DBB-01	300 x 200 x 120mm	1
DBB-02	350 x 250 x 120mm	1
DBB-03	400 x 300 x 150mm	1
DBB-04	400 x 300 x 200mm	1
DBB-05	500 x 400 x 200mm	1
DBB-06	600 x 400 x 200mm	1
DBB-07	600 x 500 x 200mm	1
DBB-08	700 x 500 x 200mm	1

BREAKER / DISTRIBUTION BOX



**ELECTRONIC**

WA 003

**DIGITAL**

WA 004



## WATT-HOUR METER MAGNETIC SUSPENSION

- Single-phase
- ERC type approved
- Voltage:240V
- Current:10(60)A
- Frequency:60Hz
- With GLASS cover

**20 PCS/CTN**



HFK

## WATERPROOF ISOLATING SWITCH

Size	166 x 83 x 86mm
Rated current	20A / 35A / 63A
IP	IP66
Material	ABS
Conductive material	Silver
Series	1P / 2P / 3P / 4P
Quantity	20 /CTN

## POWER PUSH BUTTON SWITCH BS-B



Type	No. of phases	Rated voltage	Applicable motor capacity KW	Resistance load	Weight	Sizes	Quantity
BS-210B	2.3	600V	1.1 AT 220V	7.5(10)A	0.13KG	90x44x49mm	50 PCS/CTN
BS-215B	2.3	600V	2.2 AT 220V	15(10)A	0.18KG	93x53x54mm	50 PCS/CTN
BS-230B	2.3	600V	3.7 AT 220V	22.5(10)A	0.22KG	112x62x56mm	50 PCS/CTN

# PVC ACCESSORIES

## PVC CABLE CLIP

ORANGE ●

BLUE ●

Sizes	Quantity PCS/PACK; PACK/CTN
CHR-20mm (1/2')	100 ; 50
CHR-25mm (3/4')	100 ; 50
CHR-32mm (1')	50 ; 50



(ROUND)

## PVC CABLE CLIP

WHITE ○



CHF

Items	Quantity 100 PCS/PACK PACK/CTN
Flat	PACK/CTN
CHF-4mm	500
CHF-6mm	400
CHF-8mm	250
CHF-9mm	250
CHF-10mm	200
CHF-12mm	200
CHF-14mm	125



CHR

Items	Quantity 100 PCS/PACK PACK/CTN
Round	PACK/CTN
CHR-4mm	500
CHR-6mm	300
CHR-8mm	250
CHR-9mm	200
CHR-10mm	150
CHR-12mm	100
CHR-14mm	100

PVC /  
TAPE /  
PLASTIC

## EXPAND PLUGS

WHITE ○

ORANGE ●

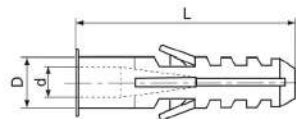

Item No.	L	D	d	Screw	50 PCS/PACK PACK/CTN
EN-05	25.0mm	4.8mm	3.2mm	Φ3x28mm	400
EN-06	29.8mm	6.0mm	4.9mm	Φ4x32mm	400
EN-07	29.8mm	7.0mm	5.3mm	Φ5x32mm	400
EN-08	39.2mm	8.0mm	5.3mm	Φ5x40mm	200
EN-10	44.0mm	9.9mm	5.8mm	Φ5x45mm	100
EN-12	48.3mm	11.6mm	6.3mm	Φ6x60mm	80

PLUGS WITH SCREW ITEM No.	Quantity 50 PCS/PACK PACK/CTN
EN-05A	200
EN-06A	200
EN-07A	150
EN-08A	100
EN-10A	80
EN-12A	50



# PVC CABLE CLIP W/BLISTER PACK

MATERIAL:  
 NYLON 66 ( UL RECOGNIZED )  
 UL FLAMMABILITY 94V.2 ( DO NOT OPEN UNTIL READY FOR USE )



## ROUND CLIP CR-3010

Sizes	PCS/PACK ; PACK/CTN	
6MM	25	1100
8MM	20	1100
9MM	18	1000
10MM	15	900
12MM	12	750
14MM	8	1100



## SQUARE CLIP CF-3020

Sizes	PCS/PACK ; PACK/CTN	
6MM	25	1400
8MM	20	1100
9MM	18	1200
10MM	15	1200
12MM	12	1500
14MM	8	1600

PVC /  
 TAPE /  
 PLASTIC



## EXPAND PLUGS EP-3030

Sizes	PCS/PACK ; PACK/CTN	
EN-05	20	900
EN-06	18	1000
EN-07	15	1200
EN-08	12	750
EN-10	8	550
EN-12	7	550



## TOX WITH SCREW EP-3040

Sizes	PCS/PACK ; PACK/CTN	
05+SCREW	15	600
06+SCREW	15	600
07+SCREW	12	500
08+SCREW	10	450
10+SCREW	7	500
12+SCREW	5	450

# PVC CABLE CLIP W/BLISTER PACK



## ROUND CLIP CR CR-1010

Sizes	PCS/PACK ; PACK/CTN	
6MM	25	100
8MM	20	100
9MM	18	100
10MM	15	100
12MM	12	100
14MM	8	100



## SQUARE CLIP CF CF-1020

Sizes	PCS/PACK ; PACK/CTN	
6MM	25	100
8MM	20	100
9MM	18	100
10MM	15	100
12MM	12	100
14MM	8	100



## TOX-BLISTER PACK EP-1030

Sizes	PCS/PACK ; PACK/CTN	
EN-05	20	100
EN-06	18	100
EN-07	15	100
EN-08	12	100
EN-10	8	100
EN-12	7	100



## TOX WITH SCREW-BLISTER PACK EP-1040

Sizes	PCS/PACK ; PACK/CTN	
05+SCREW	15	100
06+SCREW	15	100
07+SCREW	12	100
08+SCREW	10	100
10+SCREW	7	100
12+SCREW	5	100

# CABLE TIES



Sizes	WHITE ○ 25 PCS/PACK		BLACK / WHITE ●○ 100 PCS/PACK	
	PACK/CTN		PACK/CTN	
3mm	100 ( 4" )	1800	500	
	120 ( 5" )	1500	450	
	150 ( 6" )	1200	350	
	200 ( 8" )	1000	300	
4mm	150 ( 6" )	900	250	
	180 ( 7" )	800	220	
	200 ( 8" )	800	200	
	250 ( 10" )	700	180	
	300 ( 12" )	500	150	
5mm	200 ( 8" )	500	150	
	250 ( 10" )	440	130	
	300 ( 12" )	400	100	
	350 ( 14" )	350	90	

Sizes	BLACK / WHITE ●○ 50 PCS/PACK	
	PACK/CTN	
7mm	150 ( 6" )	200
	200 ( 8" )	150
	250 ( 10" )	130
	300 ( 11 <sup>5</sup> / <sub>8</sub> " )	110
	350 ( 13 <sup>3</sup> / <sub>4</sub> " )	90
8mm	370 ( 14 <sup>1</sup> / <sub>4</sub> " )	90
	400 ( 15 <sup>3</sup> / <sub>4</sub> " )	80
	450 ( 17 <sup>3</sup> / <sub>4</sub> " )	70
	500 ( 19 <sup>11</sup> / <sub>16</sub> " )	60
9mm	500 ( 19 <sup>11</sup> / <sub>16</sub> " )	50
	450 ( 17 <sup>3</sup> / <sub>4</sub> " )	50
	530 ( 20 <sup>3</sup> / <sub>4</sub> " )	40

Sizes	BLACK / WHITE ●○ 50 PCS/PACK	
	PACK/CTN	
9mm	550 ( 21 <sup>11</sup> / <sub>16</sub> " )	40
	600 ( 23 <sup>5</sup> / <sub>8</sub> " )	40
	650 ( 25 <sup>9</sup> / <sub>16</sub> " )	40
	700 ( 27 <sup>1</sup> / <sub>2</sub> " )	30
	760(thin) ( 30" )	30
	920(thin) ( 36 <sup>1</sup> / <sub>4</sub> " )	24
10mm	450 ( 17 <sup>3</sup> / <sub>4</sub> " )	50
	500 ( 19 <sup>11</sup> / <sub>16</sub> " )	40
12mm	300 ( 11 <sup>5</sup> / <sub>8</sub> " )	40
	400 ( 15 <sup>3</sup> / <sub>4</sub> " )	30
	650 ( 25 <sup>9</sup> / <sub>16</sub> " )	16
	750 ( 29 <sup>9</sup> / <sub>16</sub> " )	16

PVC / TAPE / PLASTIC

# SPIRAL WRAPPING BANDS

**SWB** OPTIONAL COLORS:  
●BLACK ○WHITE

- Material: made from PE.
- Usage: fix one end with safety belt first, then circle the wires clockwise to make them tighen.
- Application: a protection wear for electric wires, and make them insulation and look nice.

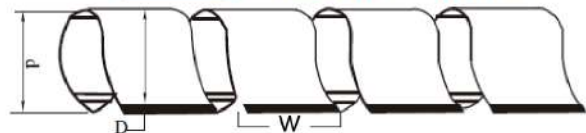

Description	Inside diameter (mm)	Outside diameter (mm)	Pitch (mm)	Wrapping range (mm)	ROLL/CTN	
					2M / ROLL	10M / ROLL
SWB-06	d	D	W			
SWB-06	4.0	6.0	7.0	4.0 - 50	360	125
SWB-08	6.0	8.0	10.8	6.0 - 60	280	70
SWB-10	7.5	10.0	11.4	7.5 - 60	180	50
SWB-12	9.0	12.0	13.9	9.0 - 65	130	35
SWB-15	12.0	15.0	15.0	12.0 - 75	100	25
SWB-19	15.0	19.0	18.2	15.0 - 100	60	20
SWB-24	20.0	24.0	19.6	20.0 - 130		10
SWB-30	26.0	30.0	43.0	26.0 - 150		6





## PACKAGING TAPE CLEAR 2"

Size: (2") 50um X 48mm X 100m  
48 PCS/CTN



## PVC MARKING TAPE

Size: 0.15mm X 48mm X 30m  
30 PCS/CTN



## PVC DUCT TAPE 2"

Grey / Black

Size: (2") 260um X 48mm X 20m  
24 PCS/CTN

PVC / TAPE / PLASTIC



## BUTYL RUBBER SEALING TAPE

Model	Sizes	PCS/CTN
RST-01	0.9mm x 50mm x 5m	36
RST-02	0.9mm x 100mm x 5m	18
RST-03	0.9mm x 150mm x 5m	12
RST-04	0.9mm x 200mm x 5m	9



## FIBERGLASS MESH TAPE

Model	Sizes	PCS/CTN
FMT-8	90mm x 25m	48
FMT-10	90mm x 25m	48



## ALUMINUM TAPE

Sizes	PCS/CTN
2" 48mm x 50Y (36mic)	24
3" 72mm x 50Y (36mic)	16



## PIPE WRAPPING TAPE FOR AIRCON

Blue / Cream white

Sizes	PCS/CTN
0.2mm x 60mm x 10m	120
0.2mm x 120mm x 10m	60



## PVC ELECTRICAL TAPE

Black / Red / Blue / Yellow / Green / White



Sizes	PCS/CTN
0.165mm x 18mm x 4m	500
0.165mm x 18mm x 16m	200

## SEALING WATERSTOP TEFLON TAPE

Model	Sizes	PCS/PACK	PCS/CTN	COLOR
TLT-01	15mm x 0.11mm x 8m x 0.25g/cm <sup>3</sup>	100	1000	White
TLT-02	19mm x 0.10mm x 10m x 0.3g/cm <sup>3</sup>	30	600	Blue



## SELF FUSING RUBBER TAPE

Model	Sizes	Tensile Strength	Elongation	Disruptive Strength	PCS/CTN
HVT-30	0.76mm x 19mm x 8m	1.3Mpa	700%	14kv/mm	60
HVT-35	0.76mm x 19mm x 9m	1.5Mpa	720%	17kv/mm	60



### MASKING TAPE 20M

**MT-03**

Sizes	PCS/CTN
1/2" 12mm	96
3/4" 18mm	64
1" 24mm	48
1-1/2" 36mm	32
2" 48mm	24



### MASKING TAPE 20M

Sizes	PCS/CTN
1/2" 12mm	96
3/4" 18mm	64
1" 24mm	48
1-1/2" 36mm	32
2" 48mm	24



### WASHI TAPE 20M

Sizes	PCS/CTN
1/2" 12mm	96
3/4" 18mm	64
1" 24mm	48
1-1/2"	
2"	

PVC /  
TAPE /  
PLASTIC



### DOUBLE -SIDED TAPE 10M

Sizes	PCS/CTN
1/2" 12mm	96
3/4" 18mm	64
1" 24mm	48



### FOAM DOUBLE-SIDED TAPE 5M

Sizes	PCS/CTN
1/2" 12mm	144
3/4" 18mm	96
1" 24mm	72



### MASKING FILM 20M

Sizes	PCS/CTN
550mm	84
1100mm	42
2100mm	42

# OTHERS



## SHORT ELBOW 90°

Size(mm)	Quantity
Φ20 (1/2')	250PCS*4PACK / 1000PCS/CTN
Φ25 (3/4')	200PCS*4PACK / 800PCS/CTN
Φ32 (1')	150PCS*4PACK / 600PCS/CTN

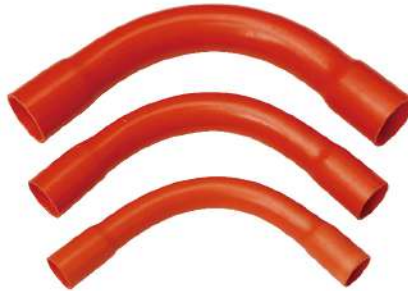

## CONDUIT LONG ELBOW 90°

Size(mm)	Quantity
Φ20 (1/2')	250 PCS/SACK
Φ25 (3/4')	200 PCS/SACK
Φ32 (1')	150 PCS/SACK



## SUC-004 SURFACE TYPE UTILITY BOX 100 PCS/CTN

PVC /  
TAPE /  
PLASTIC



## WJU-001 JUNCTION BOX 100 PCS/CTN



## WJC-003 JUNCTION COVER 1000PCS/CTN



## WUT-002 UTILITY BOX 100 PCS/CTN



## WUT-005 SQUARE BOX 5X5 40PCS/CTN 12.5X12.5X5.2CM



## PVC FLEXIBLE CONNECTOR

Size(MM)	PCS/PACK
1/2'	100 pcs/box ; 1000pcs/ctn
3/4'	100 pcs/box ; 1000pcs/ctn



## PVC PIPE CONNECTOR

Size(MM)	Quantity
Φ20 (1/2')	500 pcs/ctn
Φ25 (3/4')	250 pcs/ctn



## MALE ADAPTER WITH LOCKNUT

Size(MM)	Quantity
Φ20 (1/2')	50 pcs/pack; 20 pack/ctn
Φ25 (3/4')	50 pcs/pack; 20 pack/ctn
Φ32 (1')	25 pcs/pack; 20 pack/ctn

## FROTO PVC MOULDING

Size(MM)	PCS/BUNDLE
1/2" 12 X 12 X 2440	50 pcs/bundle
5/8" 15 X 10 X 2440	50 pcs/bundle
3/4" 20 X 12 X 2440	50 pcs/bundle
1" 25 X 12 X 2440	25 pcs/bundle
1 1/2" 40 X 12 X 2440	10 pcs/bundle
2" 50 X 12 X 2440	8 pcs/bundle



## WYNN PVC MOULDING

Size(MM)	PCS/BUNDLE
1/2" 12 X 12 X 2440	50 pcs/bundle
5/8" 15 X 10 X 2440	50 pcs/bundle
3/4" 20 X 12 X 2440	50 pcs/bundle
1" 25 X 12 X 2440	25 pcs/bundle
1 1/2" 40 X 12 X 2440	10 pcs/bundle
2" 50 X 12 X 2440	8 pcs/bundle



### WITH ADHESIVE TAPE (SQUARE)

Size(MM)	PCS/BUNDLE
5/8" 15 X 10 X 2440	50 pcs/bundle
3/4" 20 X 10 X 2440	50 pcs/bundle
1" 25 X 16 X 2440	25 pcs/bundle

PVC /  
TAPE /  
PLASTIC



### WITH ADHESIVE TAPE (ROUND)

Size(MM)	PCS/BUNDLE
1" 25 X 12 X 2440	30 pcs/bundle
1 1/5" 35 X 12 X 2440	25 pcs/bundle
2" 48 X 14 X 2440	20 pcs/bundle
2 1/2" 65 X 15 X 2440	15 pcs/bundle
4" 100 X 25 X 2440	10 pcs/bundle



### PVC SLOTTED WIRING DUCT

Item	MM	Size	Length	CTN
PXC-5050	1.5	2 X 2"	2.0M	50
PXC-6040	1.5	1.4 X 2.3"	2.0M	50
PXC-6060	1.5	2.3 X 2.3"	2.0M	40
PXC-8050	1.5	2 X 3"	2.0M	30
PXC-8080	1.5	3 X 3"	2.0M	18
PXC-100100	1.5	4 X 4"	2.0M	18

## HIGH QUALITY PVC FLEXIBLE HOSE



Sizes		Length
Millimeters	Inches	meters
20	1/2	50
20	1/2	100
25	3/4	50
25	3/4	100
32	1	50



# PVC ORANGE SANITARY PIPE



**ECO-FRIENDLY MATERIALS**

High standard environmental protection materials, in line with environmental protection PVC materials, international quality

Items	Sizes		Length	Quantity
	Millimeters	Inches	Meters	
	20	1/2	3	25 PCS/BUNDLE
	25	3/4	3	25 PCS/BUNDLE
	32	1	3	20 PCS/BUNDLE
	20	1/2	3	25 PCS/BUNDLE
	25	3/4	3	25 PCS/BUNDLE
	32	1	3	20 PCS/BUNDLE
	57	2	3	PER PIECE
	82	3	3	
	107	4	3	
	57	2	3	PER PIECE
	82	3	3	
	107	4	3	
	160	6	3	PER PIECE

PVC / TAPE / PLASTIC

## PVC SANITARY FITTINGS

	SIZE
	2"
	3"
	4"
	2" X 2"
	3" X 2"
	3" X 3"
	4" X 2"
	4" X 3"
	2"
	3"
	4"
	2" X 2"
	3" X 2"
	3" X 3"
	4" X 2"
	4" X 3"
	4" X 4"

	SIZE
	2"
	3"
	4"
	2"
	3"
	4"
	2"
	3"
	4"
	100cc
	200cc
	400cc

# LED GLOBE BULB WITH FAN

## ENERGYCLASS

CFW



Model	Voltage	Power	CAP	Lumen	LED Panel Size	Quantity
CFW 01	85-265V	12W	E27	1100	Φ105x22 mm	24 PCS/CTN
CFW 02	85-265V	18W	E27	1350	Φ125x15 mm	20 PCS/CTN

# BEDROOM FAN

CLF-01



EXHAUST FAN /  
OUTLET

Model	Voltage	Power LED+MOTOR	Lumen	Ra	LED Panel Size	Quantity
CLF-01	85-265V	30W+20W	3000	>80	500x160mm	1 PC/CTN

# LIGHTED CEILING FAN

CLF-02 IP20

- DC Motor
- Low noise operation
- Remote control with batteries included (Equipped with 6 speeds and dimming function)
- Long service life and good corrosion resistance
- Dust-proof, insect prevention (easy to maintain)



Model	Voltage	Power LED+MOTOR	Lumen	RPM	Timer	CRI	Quantity
CLF-02 42"	110-240V 50/60HZ	36W+30W	3250	100-200	2/4/8H	80	1 PC/CTN

# HALF METAL BLIND VENTILATING FAN WALL TYPE

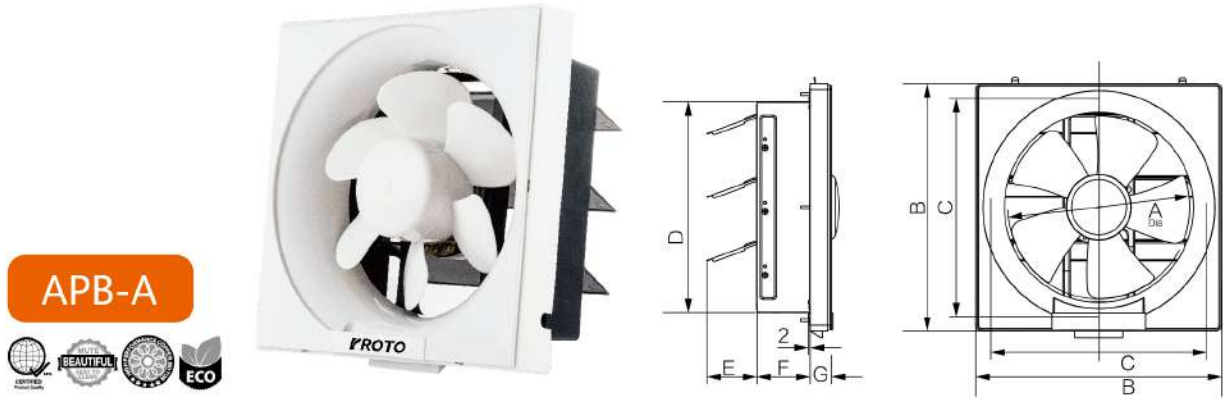

**APB-A**



Model	A	B	C	D	E	F	G
APB15-3-A 6"	155	236	208	192	70	80	40
APB20-4-A 8"	200	290	257	240	60	84	47
APB25-5-A 10"	245	338	308	290	78	84	46
APB30-6-A 12"	295	394	362	343	90	84	46

EXHAUST FAN /  
OUTLET

Model	Rated voltage	Spec	Power	Rpm	Airdelivery	Noise	Net	Quantity
APB15-3-A 6"	220V~/60Hz	150	25W	1640	4.0	46	1.28	5 PCS/CTN
APB20-4-A 8"	220V~/60Hz	200	35W	1420	9.0	47	1.45	5 PCS/CTN
APB25-5-A 10"	220V~/60Hz	250	40W	1330	13.0	48	1.68	5 PCS/CTN
APB30-6-A 12"	220V~/60Hz	300	48W	1100	20.0	50	2.18	5 PCS/CTN

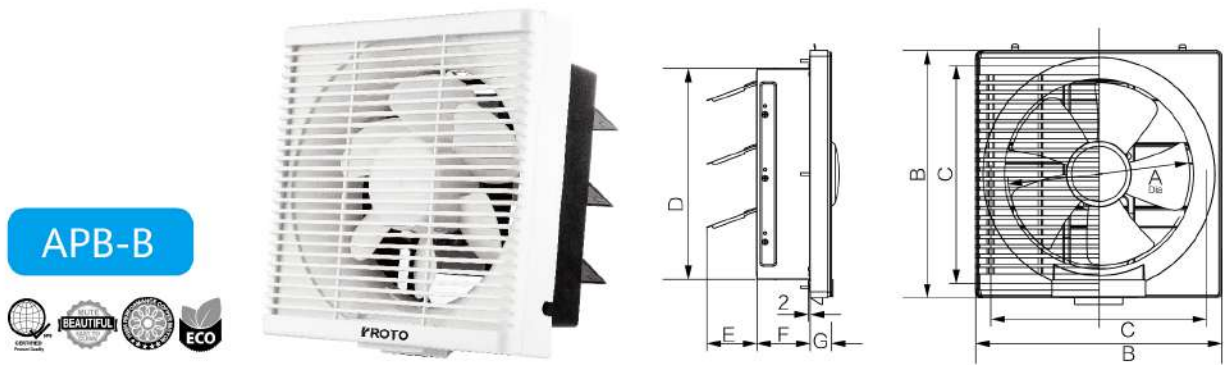

**APB-B**



Model	A	B	C	D	E	F	G
APB15-3-B 6"	155	236	208	192	70	80	75
APB20-4-B 8"	200	293	260	230	60	84	65
APB25-5-B 10"	245	338	308	290	78	84	68
APB30-6-B 12"	295	394	362	343	90	84	80

Model	Rated voltage	Spec	Power	Rpm	Airdelivery	Noise	Net	Quantity
APB15-3-B 6"	220V~/60Hz	150	25W	1640	4.0	46	1.42	5 PCS/CTN
APB20-4-B 8"	220V~/60Hz	200	35W	1420	9.0	47	1.63	5 PCS/CTN
APB25-5-B 10"	220V~/60Hz	250	40W	1330	13.0	48	1.91	5 PCS/CTN
APB30-6-B 12"	220V~/60Hz	300	48W	1100	20.0	50	2.50	5 PCS/CTN

# BATHROOM AND WINDOW VENTILATING FAN



Model	A	B	C	D	ΦE
APC 10-2-B 4"	150	150	18	75	98
APC 15-3-C 6"	204	220	21	90	150
APC 20-4-A 8"	234	254	20	101	178

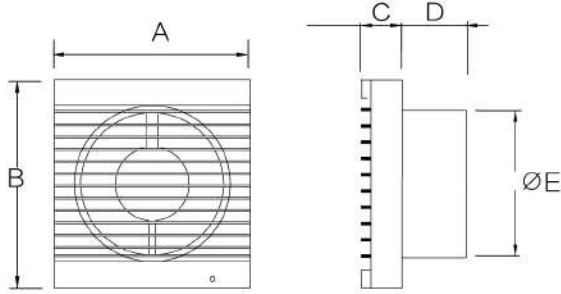

Model	Rated voltage	Spec	Power	Rpm	Airdelivery	Noise	Net	Quantity
APC 10-2-B 4"	220V~/60Hz	100	9W	2600	1.0	43	0.52	10 PCS/CTN
APC 15-3-C 6"	220V~/60Hz	150	15W	1600	3.0	48	0.88	10 PCS/CTN
APC 20-4-A 8"	220V~/60Hz	200	19W	1470	4.2	52	1.06	10 PCS/CTN

EXHAUST FAN /  
OUTLET

# TUBULAR VENTILATING FAN CEILING TYPE



Model	A	B	C	D	ΦE
BPT10-13H20 10"	207	213	246	30	98
BPT10-23H25 12"	250	265	300	30	98
BPT15-33H45 14"	288	303	340	35	98
BPT18-35H60 24"	473	525	595	40	148

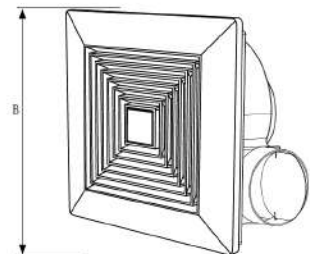
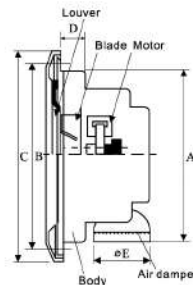

Model	Rated voltage	Spec	Power	Rpm	Airdelivery	Noise	Net	Quantity
BPT10-13H20 10"	220V~/60Hz	200	28W	1240	2.0	43	1.28	5 PCS/CTN
BPT10-23H25 12"	220V~/60Hz	250	35W	1000	3.0	46	1.60	5 PCS/CTN
BPT15-33H45 14"	220V~/60Hz	300	40W	850	3.5	48	2.02	5 PCS/CTN
BPT18-35H60 24"	220V~/50Hz	150	88W	780	7.0	46	5.10	1 PCS/CTN

# CEILING FAN BPT18-35H60/01

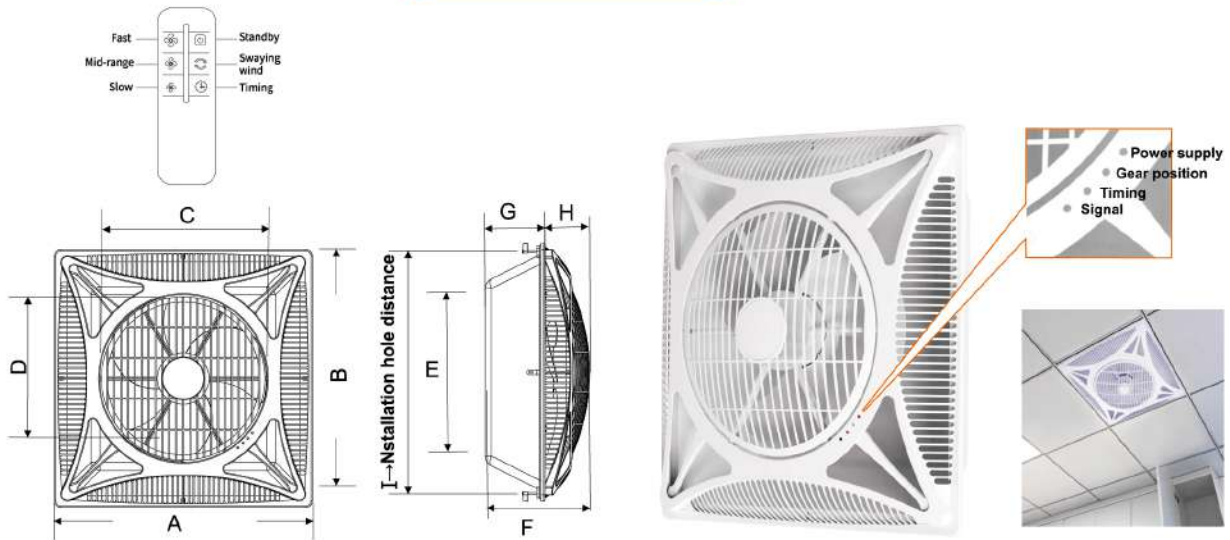

Model	A	B	C	D	E	F	G	H	I
BPT18-35H60/01	600	600	380	350	450	162	90	85	572

Model	Rated voltage	Power Fast / Mid-range / Slow	Fast Volume	Rpm Fast / Mid-range / Slow	Noise	Quantity
BPT18-35H60/01	220V~/60Hz	72W / 58W / 51W	65 m <sup>3</sup> /min	1452 / 1278 / 1078	64	1 PCS/CTN

EXHAUST FAN /  
OUTLET

# INDUSTRIAL EXHAUST FAN



FPK

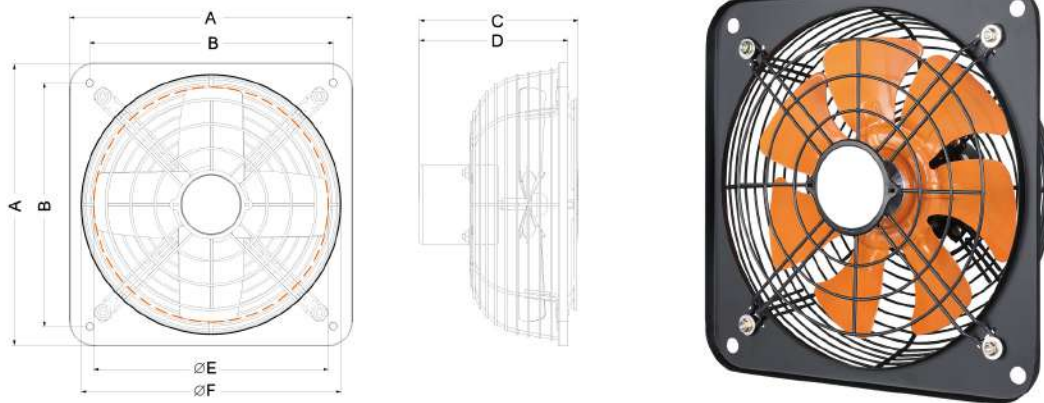

Model	Outer frame Spec	C	D	ØE	Vent ØF	Power	Rpm	Quantity
FPK-30 12"	352x352	165	155	285	315	35W	1300	3 PCS/CTN
FPK-35 14"	409x409	180	170	325	371	50W	1300	3 PCS/CTN
FPK-40 16"	479x479	255	250	375	414	100W	1400	3 PCS/CTN
FPK-50 20"	600x600	258	252	475	518	180W	1360	3 PCS/CTN

# ALUMINUM FLEXIBLE AIR VENTILATION DUCT

INCREASE DENSITY

THICKEN

MORE DURABLE



AFA

THICKNESS	0.023-0.025	0.023-0.025
DIAMETER	4"—10cm	6"—15cm
QUANTITY	1M 45 PCS/CTN	1.5M 45 PCS/CTN
QUANTITY	2M 30 PCS/CTN	2.0M 30 PCS/CTN

# STAINLESS STEEL FLOOR DRAIN #304

SSF



Description	Diameter(mm)	Depth(mm)	Throat(mm)	Quantity
SSF-03 3"	82	115	67	24PCS/CTN
SSF-04 4"	125	115	95	24PCS/CTN
SSF-06 6"	175	130	145	24PCS/CTN

EXHAUST FAN /  
OUTLET

# METAL VENT CAP

MVC Aluminum #304

Description	Voltage	A(mm)	B(mm)	C(mm)	Quantity
MVC-4"	4" /100mm	97	132	52	24PCS/CTN
MVC-6"	6" /150mm	145	192	62	24PCS/CTN

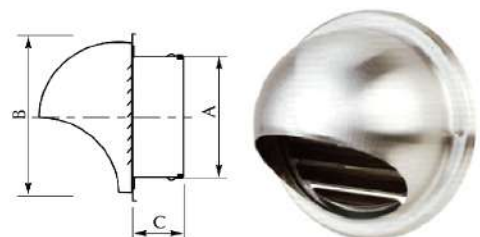

# WALL SWITCH & OUTLET CLASSIC SERIES FUNCTIONAL MODULE



AVAILABLE COLOERS: ORIGINAL ○ CHAMPAGNE GOLD ● SHADOW GRAY ●



WEATHER PROOF  
COVER-THIN  
120 PCS/CTN

**BW-002**



BLANK PLATE  
10A 250V  
10 PCS/BOX  
200 PCS/CTN

**WWO-100**



1 GANG PLATE  
10A 250V  
10 PCS/BOX  
200 PCS/CTN

**WWO-101**



2 GANG PLATE  
10A 250V  
10 PCS/BOX  
200 PCS/CTN

**WWO-102**



3 GANG PLATE  
10A 250V  
10 PCS/BOX  
200 PCS/CTN

**WWO-103**



1 WAY SWITCH  
1 GANG  
10A 250V  
10 PCS/BOX  
100 PCS/CTN

**WO-501**



1 WAY SWITCH  
2 GANG  
10A 250V  
10 PCS/BOX  
100 PCS/CTN

**WO-503**



1 WAY SWITCH  
3 GANG  
10A 250V  
10 PCS/BOX  
100 PCS/CTN

**WO-505**



1 WAY SWITCH  
1 GANG OUTLET  
10A 250V  
10PCS/BOX  
100PCS/CTN

**WO-511**



1 GANG OUTLET  
10A 250V  
10 PCS/BOX  
100 PCS/CTN

**WO-111**



2 GANG OUTLET  
10A 250V  
10 PCS/BOX  
100 PCS/CTN

**WO-113**



3 GANG OUTLET  
10A 250V  
10 PCS/BOX  
100 PCS/CTN

**WO-115**



1 GANG CONV OUTLET  
10A 250V  
10 PCS/BOX  
100 PCS/CTN

**WO-105**



2 GANG CONV OUTLET  
10A 250V  
10 PCS/BOX  
100 PCS/CTN

**WO-105-2**



3 GANG CONV OUTLET  
10A 250V  
10 PCS/BOX  
100 PCS/CTN

**WO-105-3**



2 GANG UNIVERSAL  
OUTLET W/GROUND  
10A 250V  
10 PCS/BOX  
100 PCS/CTN

**WO-155**



1 GANG CONV  
OUTLET W/GROUND  
10A 250V  
10 PCS/BOX  
100 PCS/CTN

**WPO-1203**



1 GANG BELL  
BUTTON SWITCH  
10A 250V  
10 PCS/BOX  
100 PCS/CTN

**WO-202**

EXHAUST FAN /  
OUTLET



2 GANG USB OUTLET  
2100MA 5V  
8 PCS/BOX  
80 PCS/CTN  
**WO-302**



1 GANG TELEPHONE OUTLET  
10A 250V  
10 PCS/BOX  
100 PCS/CTN  
**WO-403**



1 GANG MODULAR OUTLET  
10A 250V  
10 PCS/BOX  
100 PCS/CTN  
**WO-412**



1 GANG TV CABLE OUTLET  
2100MA 5V  
10 PCS/BOX  
100 PCS/CTN  
**WO-301**



1 GANG DIMMER SWITCH  
10A 250V  
6 PCS/BOX  
60 PCS/CTN  
**WO-540S**



1 WAY SWITCH  
10A 250V  
10 PCS/BOX  
500 PCS/CTN  
**WPO-6008**



1WAY SWITCH  
10A 250V  
10 PCS/BOX  
500 PCS/CTN  
**WPO-6008A**



3 WAY SWITCH  
10A 250V  
10 PCS/BOX  
500 PCS/CTN  
**WPO-6008B**



UNIVERSAL OUTLET  
W/SHUTTER  
10A 250V  
10 PCS/BOX  
500 PCS/CTN  
**WPO-6009**



ELECTRICAL OUTLET  
10A 250V  
10 PCS/BOX  
500 PCS/CTN  
**WPO-6009A**



ELECTRICAL OUTLET  
W/GROUND  
10A 250V  
10 PCS/BOX  
500 PCS/CTN  
**WPO-6009B**



2 GANG UNIVERSAL  
OUTLET W/GROUND  
10A 250V  
30 PCS/BOX  
300 PCS/CTN  
**WPO-6009C**



TV CABLE OUTLET  
10A 250V  
10 PCS/BOX  
500 PCS/CTN  
**WTV-101**



COMPUTER MODULAR  
OUTLET  
10A 250V  
10 PCS/BOX  
500 PCS/CTN  
**WPO-201**



TELEPHONE OUTLET  
10A 250V  
10 PCS/BOX  
500 PCS/CTN  
**WPO-202**



BELL PUSH BUTTON  
10A 250V  
10 PCS/BOX  
500 PCS/CTN  
**WPO-203**



DIMMER SWITCH  
10A 250V  
10 PCS/BOX  
500 PCS/CTN  
**WPO-204**

EXHAUST FAN /  
OUTLET

# WALL SWITCH & OUTLET

## FUNCTIONAL MODULE WIDE SERIES

AVAILABLE ORIGINAL  CHAMPAGNE GOLD  SHADOW GRAY 

COLOERS:



BLANK PANEL PLATE  
10A 250V  
10 PCS/BOX  
200 PCS/CTN  
**EWO-200**

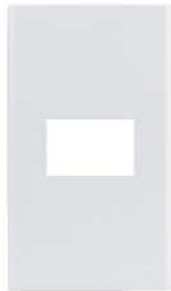

1 GANG PLATE  
10A 250V  
10 PCS/BOX  
200 PCS/CTN  
**EWO-201**

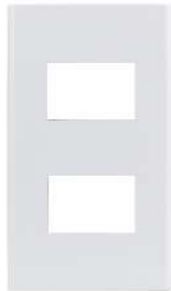

2 GANG PLATE  
10A 250V  
10 PCS/BOX  
200 PCS/CTN  
**EWO-202**

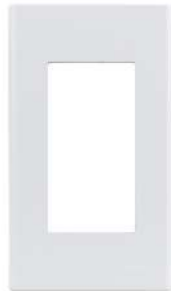

3 GANG PLATE  
10A 250V  
10 PCS/BOX  
200 PCS/CTN  
**EWO-203**

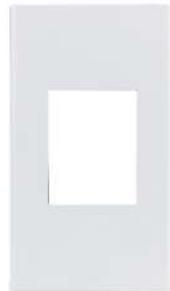

1 GANG PLATE  
10A 250V  
10 PCS/BOX  
200 PCS/CTN  
**EWO-212**



1 WAY SWITCH  
1 GANG  
10A 250V  
10 PCS/BOX  
100 PCS/CTN  
**E0-601**

EXHAUST FAN /  
OUTLET



1 WAY SWITCH  
1 GANG  
10A 250V  
10 PCS/BOX  
100 PCS/CTN  
**E0-601A**



1WAY SWITCH  
2 GANG  
10A 250V  
10 PCS/BOX  
100 PCS/CTN  
**E0-603**



1WAY SWITCH  
2 GANG  
10A 250V  
10 PCS/BOX  
100 PCS/CTN  
**E0-603A**



1 WAY SWITCH  
3 GANG  
10A 250V  
10 PCS/BOX  
100 PCS/CTN  
**E0-605**



COMBINED SWITCH  
OUTLET 2 GANG  
10A 250V  
10 PCS/BOX  
100 PCS/CTN  
**E0-611**



1GANG OUTLET  
10A 250V  
10 PCS/BOX  
100 PCS/CTN  
**E0-211**



2 GANG OUTLET  
10A 250V  
10 PCS/BOX  
100 PCS/CTN  
**E0-213**



3 GANG OUTLET  
10A 250V  
10 PCS/BOX  
100 PCS/CTN  
**E0-215**



1 GANG  
CONVENIENCE OUTLET  
10A 250V  
10 PCS/BOX  
100 PCS/CTN  
**E0-205**



2 GANG  
CONVENIENCE OUTLET  
10A 250V  
10 PCS/BOX  
100 PCS/CTN  
**E0-205/2**



3 GANG  
CONVENIENCE OUTLET  
10A 250V  
10 PCS/BOX  
100 PCS/CTN  
**E0-205/3**



1 GANG UNIVERSAL  
OUTLET W/GROUND  
10A 250V  
10 PCS/BOX  
100 PCS/CTN  
**E0-235**



2 GANG UNIVERSAL  
OUTLET W/GROUND  
10A 250V  
10 PCS/BOX  
100 PCS/CTN  
**EO-255**



1 GANG  
10A 250V  
10 PCS/BOX  
100 PCS/CTN  
**EO-236**



2 GANG  
10A 250V  
10 PCS/BOX  
100 PCS/CTN  
**EO-256**



AIRCON TANDEM  
OUTLET  
10A 250V  
10 PCS/BOX  
100 PCS/CTN  
**EPO-1505**



1 GANG  
BELL PUSH BUTTON  
10A 250V  
10 PCS/BOX  
100 PCS/CTN  
**EO-302**



1 GANG USB OUTLET  
10A 250V  
8 PCS/BOX  
80 PCS/CTN  
**EO-301A**



1 GANG  
TELEPHONE OUTLET  
10A 250V  
10 PCS/BOX  
100 PCS/CTN  
**EO-501**



1 GANG COMPUTER  
MODULAR OUTLET  
10A 250V  
10 PCS/BOX  
100 PCS/CTN  
**EO-512**



1 GANG  
TV CABLE OUTLET  
10A 250V  
10 PCS/BOX  
100 PCS/CTN  
**EO-401**



1 GANG  
DIMMER SWITCH  
10A 250V  
6 PCS/BOX  
60 PCS/CTN  
**EO-640S**



INDUCTION SWITCH  
WITH SENSOR  
AC 220V 50HZ  
5 PCS/BOX  
50 PCS/CTN  
**MRT203-118GY**



1 WAY SWITCH  
10A 250V  
10 PCS/BOX  
500 PCS/CTN  
**EPO-7005**



3 WAY SWITCH  
10A 250V  
10 PCS/BOX  
500 PCS/CTN  
**EPO-7005B**



UNIVERSAL OUTLET  
W/SHUTTER  
10A 250V  
10 PCS/BOX  
500 PCS/CTN  
**EPO-7006**



CONVENIENCE  
OUTLET W/GROUND  
10A 250V  
10 PCS/BOX  
500 PCS/CTN  
**EPO-7006B**



1 GANG UNIVERSAL  
OUTLET W/GROUND  
10A 250V (36MM)  
6 PCS/BOX  
300 PCS/CTN  
**EPO-7016**



UNIVERSAL OUTLET  
W/GROUND  
10A 250V (47MM)  
4 PCS/BOX  
200 PCS/CTN  
**EPO-7006C**



1 GANG UNIVERSAL  
OUTLET W/GROUND  
10A 250V (47MM)  
6 PCS/BOX  
300 PCS/CTN  
**EPO-7016A**



2 GANG UNIVERSAL  
OUTLET W/GROUND  
10A 250V  
30 PCS/BOX  
300 PCS/CTN  
**EPO-7006D**



TV CABLE OUTLET  
10A 250V  
10 PCS/BOX  
500 PCS/CTN  
**ETV-201**



COMPUTER MODULAR  
OUTLET  
10A 250V  
10 PCS/BOX  
500 PCS/CTN  
**EPO-301**



TELEPHONE OUTLET  
10A 250V  
10 PCS/BOX  
500 PCS/CTN  
**EPO-302**



BELL PUSH BUTTON  
10A 250V  
10 PCS/BOX  
500 PCS/CTN  
**EPO-303**



DIMMER SWITCH  
10A 250V  
4 PCS/BOX  
200 PCS/CTN  
**EPO-304**

EXHAUST FAN /  
OUTLET

# L-SERIES-WHITE



1 GANG PLATE  
10A 250V  
15 PCS/BOX  
150 PCS/CTN  
**LWC-100**



1 GANG PLATE  
10A 250V  
20 PCS/BOX  
100 PCS/CTN  
**LWC-301**



2 GANG PLATE  
10A 250V  
20 PCS/BOX  
100 PCS/CTN  
**LWC-302**



3 GANG PLATE  
10A 250V  
20 PCS/BOX  
100 PCS/CTN  
**LWC-303**



1 GANG  
1 WAY SWITCH  
10A 250V  
10 PCS/BOX  
100 PCS/CTN  
**LO-301**



1 GANG  
1WAY SWITCH  
10A 250V  
10 PCS/BOX  
100 PCS/CTN  
**LO-301A**



2 GANG  
1WAY SWITCH  
10A 250V  
10 PCS/BOX  
100 PCS/CTN  
**LO-302**



2 GANG  
1WAY SWITCH  
10A 250V  
10 PCS/BOX  
100 PCS/CTN  
**LO-302A**



3 GANG  
1WAY SWITCH  
10A 250V  
10 PCS/BOX  
100 PCS/CTN  
**LO-303**



1 GANG OUTLET  
10A 250V  
10 PCS/BOX  
100 PCS/CTN  
**LO-201**



2 GANG OUTLET  
10A 250V  
10 PCS/BOX  
100 PCS/CTN  
**LO-202**

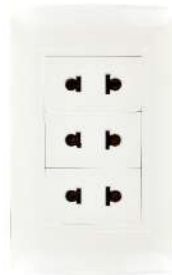

3 GANG OUTLET  
10A 250V  
10 PCS/BOX  
100 PCS/CTN  
**LO-203**

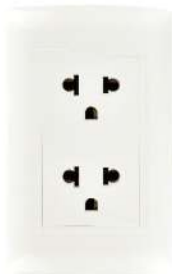

2 GANG  
UNIVERSAL OUTLET  
10A 250V  
10 PCS/BOX  
100 PCS/CTN  
**LO-507**



1 GANG  
CONV OUTLET  
10A 250V  
10 PCS/BOX  
100 PCS/CTN  
**LO-207**



2 GANG  
CONV OUTLET  
10A 250V  
10 PCS/BOX  
100 PCS/CTN  
**LO-307**



1 GANG  
BELL SWITCH  
10A 250V  
10 PCS/BOX  
100 PCS/CTN  
**LO-501**



1 GANG TELEPHONE  
1GANG CABLE TV OUTLET  
10A 250V  
10 PCS/BOX  
100 PCS/CTN  
**LO-508**



1 GANG  
COMPUTER OUTLET  
10A 250V  
10 PCS/BOX  
100 PCS/CTN  
**LO-503**

EXHAUST FAN /  
OUTLET



1 GANG  
TELEPHONE OUTLET  
10A 250V  
10 PCS/BOX  
100 PCS/CTN  
**LPO-109**



1 WAY SWITCH  
10A 250V  
10 PCS/BOX  
500 PCS/CTN  
**LPO-8005-2**



1 WAY SWITCH  
10A 250V  
10 PCS/BOX  
500 PCS/CTN  
**LPO-8005-1**



1 WAY SWITCH  
10A 250V  
10 PCS/BOX  
500 PCS/CTN  
**LPO-8005**



3 WAY SWITCH  
10A 250V  
10 PCS/BOX  
500 PCS/CTN  
**LPO-8005B**



CONVENIENCE OUTLET  
10A 250V  
10 PCS/BOX  
500 PCS/CTN  
**LPO-8006A**



UNIVERSAL OUTLET  
10A 250V  
10 PCS/BOX  
500 PCS/CTN  
**LPO-8006**



CONVENIENCE OUTLET  
10A 250V  
10 PCS/BOX  
500 PCS/CTN  
**LPO-8006B**



2 GANG  
UNIVERSAL OUTLET  
10A 250V  
10 PCS/BOX  
500 PCS/CTN  
**LPO-8006B-2**



2 GANG USB OUTLET  
10A 250V  
4 PCS/BOX  
200 PCS/CTN  
**LPO-102**



BUTTON SWITCH  
10A 250V  
10 PCS/BOX  
500 PCS/CTN  
**LPO-107**



TELEPHONE OUTLET  
10A 250V  
10 PCS/BOX  
500 PCS/CTN  
**LPO-105**



COMPUTER MODULAR OUTLET  
10A 250V  
10 PCS/BOX  
500 PCS/CTN  
**LPO-106**



DIMMER SWITCH  
10A 250V  
4 PCS/BOX  
200 PCS/CTN  
**LPO-104**



TV CABLE OUTLET  
10A 250V  
10 PCS/BOX  
500 PCS/CTN  
**LTV-103**



BLANK FILTER  
10A 250V  
10 PCS/BOX  
500 PCS/CTN  
**LEO-001**

EXHAUST FAN /  
OUTLET

# L-SERIES-SHADOW GRAY



1 GANG PLATE  
10A 250V  
20 PCS/BOX  
100 PCS/CTN

LWC-301/SD



2 GANG PLATE  
10A 250V  
20 PCS/BOX  
100 PCS/CTN

LWC-302/SD



3 GANG PLATE  
10A 250V  
20 PCS/BOX  
100 PCS/CTN

LWC-303/SD



1 GANG  
1 WAY SWITCH  
10A 250V  
10 PCS/BOX  
100 PCS/CTN

LO-301/SD



1 GANG  
1WAY SWITCH  
10A 250V  
10 PCS/BOX  
100 PCS/CTN

LO-301A/SD

EXHAUST FAN /  
OUTLET



2 GANG  
1WAY SWITCH  
10A 250V  
10 PCS/BOX  
100 PCS/CTN

LO-302/SD



2 GANG  
1WAY SWITCH  
10A 250V  
10 PCS/BOX  
100 PCS/CTN

LO-302A/SD



3 GANG  
1WAY SWITCH  
10A 250V  
10 PCS/BOX  
100 PCS/CTN

LO-303/SD



1 GANG OUTLET  
10A 250V  
10 PCS/BOX  
100 PCS/CTN

LO-201/SD



2 GANG OUTLET  
10A 250V  
10 PCS/BOX  
100 PCS/CTN

LO-202/SD



3 GANG OUTLET  
10A 250V  
10 PCS/BOX  
100 PCS/CTN

LO-203/SD



2 GANG  
UNIVERSAL OUTLET  
10A 250V  
10 PCS/BOX  
100 PCS/CTN

LO-507/SD



1 GANG  
COMPUTER OUTLET  
10A 250V  
10 PCS/BOX  
100 PCS/CTN

LO-503/SD



1 GANG  
TELEPHONE OUTLET  
10A 250V  
10 PCS/BOX  
100 PCS/CTN

LO-109/SD



1 WAY SWITCH  
10A 250V  
10 PCS/BOX  
500 PCS/CTN

LPO-8005-2/SD



1 WAY SWITCH  
10A 250V  
10 PCS/BOX  
500 PCS/CTN

LPO-8005-1/SD



1 WAY SWITCH  
10A 250V  
10 PCS/BOX  
500 PCS/CTN

LPO-8005/SD



3 WAY SWITCH  
10A 250V  
10 PCS/BOX  
500 PCS/CTN

LPO-8005B/SD



UNIVERSAL OUTLET  
10A 250V  
10 PCS/BOX  
500 PCS/CTN

LPO-8006/SD



2 GANG  
UNIVERSAL OUTLET  
10A 250V  
10 PCS/BOX  
500 PCS/CTN

LPO-8006B-2/SD



TELEPHONE OUTLET  
10A 250V  
10 PCS/BOX  
500 PCS/CTN

LPO-105/SD



COMPUTER MODULAR OUTLET  
10A 250V  
10 PCS/BOX  
500 PCS/CTN

LPO-106/SD



TV CABLE OUTLET  
10A 250V  
10 PCS/BOX  
500 PCS/CTN

LTV-103/SD



EXHAUST FAN /  
OUTLET

# L-SERIES-CHAMPAGNE GOLD



1 GANG PLATE  
10A 250V  
20 PCS/BOX  
100 PCS/CTN

LWC-301/CG



2 GANG PLATE  
10A 250V  
20 PCS/BOX  
100 PCS/CTN

LWC-302/CG



3 GANG PLATE  
10A 250V  
20 PCS/BOX  
100 PCS/CTN

LWC-303/CG



1 GANG  
1 WAY SWITCH  
10A 250V  
10 PCS/BOX  
100 PCS/CTN

LO-301/CG



1 GANG  
1WAY SWITCH  
10A 250V  
10 PCS/BOX  
100 PCS/CTN

LO-301A/CG

EXHAUST FAN /  
OUTLET



2 GANG  
1WAY SWITCH  
10A 250V  
10 PCS/BOX  
100 PCS/CTN

LO-302/CG



2 GANG  
1WAY SWITCH  
10A 250V  
10 PCS/BOX  
100 PCS/CTN

LO-302A/CG



3 GANG  
1WAY SWITCH  
10A 250V  
10 PCS/BOX  
100 PCS/CTN

LO-303/CG



1 GANG OUTLET  
10A 250V  
10 PCS/BOX  
100 PCS/CTN

LO-201/CG



2 GANG OUTLET  
10A 250V  
10 PCS/BOX  
100 PCS/CTN

LO-202/CG



3 GANG OUTLET  
10A 250V  
10 PCS/BOX  
100 PCS/CTN

LO-203/CG



2 GANG  
UNIVERSAL OUTLET  
10A 250V  
10 PCS/BOX  
100 PCS/CTN

LO-507/CG



1 GANG  
COMPUTER OUTLET  
10A 250V  
10 PCS/BOX  
100 PCS/CTN

LO-503/CG



1 GANG  
TELEPHONE OUTLET  
10A 250V  
10 PCS/BOX  
100 PCS/CTN

LO-109/CG



1 WAY SWITCH  
10A 250V  
10 PCS/BOX  
500 PCS/CTN

LPO-8005-2/CG



1 WAY SWITCH  
10A 250V  
10 PCS/BOX  
500 PCS/CTN

LPO-8005-1/CG



1 WAY SWITCH  
10A 250V  
10 PCS/BOX  
500 PCS/CTN

LPO-8005/CG



3 WAY SWITCH  
10A 250V  
10 PCS/BOX  
500 PCS/CTN

LPO-8005B/CG



UNIVERSAL OUTLET  
10A 250V  
10 PCS/BOX  
500 PCS/CTN

LPO-8006/CG



2 GANG  
UNIVERSAL OUTLET  
10A 250V  
10 PCS/BOX  
500 PCS/CTN

LPO-8006B-2/CG



TELEPHONE OUTLET  
10A 250V  
10 PCS/BOX  
500 PCS/CTN

LPO-105/CG



COMPUTER MODULAR OUTLET  
10A 250V  
10 PCS/BOX  
500 PCS/CTN

LPO-106/CG



TV CABLE OUTLET  
10A 250V  
10 PCS/BOX  
500 PCS/CTN

LTV-103/CG



EXHAUST FAN /  
OUTLET

# ELECTRICAL FLOOR OUTLET



● SILVER  
● GOLD  
● DARK GRAY  
 FLOOR OUTLET SQUARE  
 10A 250V 2 GANG  
 20 PCS/CTN

**FOR-1**



● SILVER  
● GOLD  
● DARK GRAY  
 FLOOR OUTLET SQUARE  
 10A 250V 3 GANG  
 20 PCS/CTN

**FOR-2**



FLOOR OUTLET ROUND-SILVER  
 10A 250V 3 GANG  
 20 PCS/CTN

**WER-1**



FLOOR OUTLET ROUND-GOLD  
 10A 250V 3 GANG  
 20 PCS/CTN

**WER-3**



FLOOR OUTLET SQUARE-SILVER  
 10A 250V 3 GANG  
 20 PCS/CTN

**WER-2**



FLOOR OUTLET SQUARE-GOLD  
 10A 250V 3 GANG  
 20 PCS/CTN

**WER-4**



FLOOR OUTLET SQUARE-SILVER  
 10A 250V 2 GANG  
 20 PCS/CTN

**WER-2A**



FLOOR OUTLET SQUARE-GOLD  
 10A 250V 2 GANG  
 20 PCS/CTN

**WER-4A**



FLOOR COMPUTER OUTLET SQUARE-SILVER  
 3 CAT.6 DATA  
 20 PCS/CTN

**WER-5**



FLOOR COMPUTER OUTLET SQUARE-GOLD  
 3 CAT.6 DATA  
 20 PCS/CTN

**WER-5A**

EXHAUST FAN /  
OUTLET



# DECORATIVE AND PRACTICAL

LED WALL LIGHT  
LED SPIKE LIGHT

## LED WALL LIGHT

WALL LIGHT



**WL160**

<b>Watt</b>	12W
<b>CCT Optional</b>	3000K
<b>Lumen</b>	780LM
<b>Voltage</b>	100-240V 50/60HZ
<b>CRI</b>	≥70
<b>IP</b>	IP65
<b>Beam angle</b>	110°
<b>Size</b>	265 X 120 X 81 MM
<b>P.F:</b>	0.45
<b>Quantity</b>	20 PCS/CTN



**WL260**

<b>Watt</b>	6W
<b>CCT Optional</b>	3000K
<b>Lumen</b>	220LM
<b>Voltage</b>	100-240V 50/60HZ
<b>CRI</b>	≥70
<b>IP</b>	IP65
<b>Beam angle</b>	26°
<b>Size</b>	220 X 112 X 50 MM
<b>P.F:</b>	0.45
<b>Quantity</b>	20 PCS/CTN



**WL360**

<b>Watt</b>	9W
<b>CCT Optional</b>	3000K
<b>Lumen</b>	530LM
<b>Voltage</b>	100-240V 50/60HZ
<b>CRI</b>	≥70
<b>IP</b>	IP65
<b>Beam angle</b>	90°
<b>Size</b>	173 X 81 X 46 MM
<b>P.F:</b>	0.45
<b>Quantity</b>	50 PCS/CTN

# LED WALL LIGHT



**WL460**

<b>Watt</b>	12W
<b>CCT Optional</b>	3000K
<b>Lumen</b>	900LM
<b>Voltage</b>	100-240V 50/60HZ
<b>CRI</b>	≥70
<b>IP</b>	IP65
<b>Beam angle</b>	118°
<b>Size</b>	230 X 110 X 76 MM
<b>P.F:</b>	0.45
<b>Quantity</b>	20 PCS/CTN



**WL460A**

<b>Watt</b>	12W
<b>CCT Optional</b>	3000K
<b>Lumen</b>	900LM
<b>Voltage</b>	100-240V 50/60HZ
<b>CRI</b>	≥70
<b>IP</b>	IP65
<b>Beam angle</b>	117°
<b>Size</b>	230 X 110 X 76 MM
<b>P.F:</b>	0.5
<b>Quantity</b>	20 PCS/CTN



**WL460B**

<b>Watt</b>	12W
<b>CCT Optional</b>	3000K
<b>Lumen</b>	1200LM
<b>Voltage</b>	100-240V 50/60HZ
<b>CRI</b>	≥70
<b>IP</b>	IP65
<b>Beam angle</b>	130°
<b>Size</b>	230 X 110 X 76 MM
<b>P.F:</b>	0.45
<b>Quantity</b>	20 PCS/CTN

WALL LIGHT

# LED WALL LIGHT



**WL1210**

<b>Watt</b>	8W
<b>CCT Optional</b>	3000K
<b>Lumen</b>	460LM
<b>Voltage</b>	100-240V 50/60HZ
<b>CRI</b>	≥70
<b>IP</b>	IP20
<b>Beam angle</b>	140°
<b>Size</b>	100 X 160 X 100 MM
<b>P.F:</b>	0.5
<b>Quantity</b>	50 PCS/CTN



**WL0641**

<b>Watt</b>	8W
<b>CCT Optional</b>	3000K
<b>Lumen</b>	480LM
<b>Voltage</b>	100-240V 50/60HZ
<b>CRI</b>	≥70
<b>IP</b>	IP65
<b>Beam angle</b>	140°
<b>Size</b>	120 X 120 X 92 MM
<b>P.F:</b>	0.5
<b>Quantity</b>	20 PCS/CTN



# LED WALL LIGHT



**WL1320**

<b>Watt</b>	8W
<b>CCT Optional</b>	3000K
<b>Lumen</b>	560LM
<b>Voltage</b>	100-240V 50/60HZ
<b>CRI</b>	≥80
<b>IP</b>	IP20
<b>Beam angle</b>	170°
<b>Size</b>	198 X 90 X 30 MM
<b>P.F:</b>	≥0.5
<b>Quantity</b>	40 PCS/CTN



**WL1330**

<b>Watt</b>	12W
<b>CCT Optional</b>	3000K
<b>Lumen</b>	580LM
<b>Voltage</b>	100-240V 50/60HZ
<b>CRI</b>	≥70
<b>IP</b>	IP20
<b>Beam angle</b>	166°
<b>Size</b>	315 X 90 X 30 MM
<b>P.F:</b>	≥0.5
<b>Quantity</b>	20 PCS/CTN

# LED WALL LIGHT



**WL1110**

<b>Watt</b>	8W
<b>CCT Optional</b>	3000K
<b>Lumen</b>	320LM
<b>Voltage</b>	100-240V 50/60HZ
<b>CRI</b>	≥70
<b>IP</b>	IP20
<b>Beam angle</b>	130°
<b>Size</b>	100 X 62 X 108 MM
<b>P.F:</b>	0.5
<b>Quantity</b>	50 PCS/CTN



**WL4460**

<b>Watt</b>	12W
<b>CCT Optional</b>	3000K
<b>Lumen</b>	1320LM
<b>Voltage</b>	100-240V 50/60HZ
<b>CRI</b>	≥80
<b>IP</b>	IP65
<b>Beam angle</b>	100°
<b>Size</b>	Ø160 X 60 MM
<b>P.F:</b>	>0.5
<b>Quantity</b>	50 PCS/CTN



WALL LIGHT



# LED WALL LIGHT



**WL2340A**

<b>Watt</b>	7W
<b>CCT Optional</b>	3000K
<b>Lumen</b>	546LM
<b>Voltage</b>	100-240V 50/60HZ
<b>CRI</b>	≥70
<b>IP</b>	IP65
<b>Beam angle</b>	165°
<b>Size</b>	Φ133 X 67 MM
<b>P.F:</b>	>0.5
<b>Quantity</b>	50 PCS/CTN



**WL2340B**

<b>Watt</b>	7W
<b>CCT Optional</b>	3000K
<b>Lumen</b>	600LM
<b>Voltage</b>	100-240V 50/60HZ
<b>CRI</b>	≥70
<b>IP</b>	IP65
<b>Beam angle</b>	128°
<b>Size</b>	Φ133 X 67 MM
<b>P.F:</b>	>0.5
<b>Quantity</b>	50 PCS/CTN

WALL LIGHT

# LED WALL LIGHT



**WL2440A**

<b>Watt</b>	7W
<b>CCT Optional</b>	3000K
<b>Lumen</b>	546LM
<b>Voltage</b>	100-240V 50/60HZ
<b>CRI</b>	≥70
<b>IP</b>	IP65
<b>Beam angle</b>	165°
<b>Size</b>	Φ133 X 67 MM
<b>P.F:</b>	>0.5
<b>Quantity</b>	20 PCS/CTN



**WL2440B**

<b>Watt</b>	7W
<b>CCT Optional</b>	3000K
<b>Lumen</b>	580LM
<b>Voltage</b>	100-240V 50/60HZ
<b>CRI</b>	≥70
<b>IP</b>	IP65
<b>Beam angle</b>	128°
<b>Size</b>	133 X 133 X 67 MM
<b>P.F:</b>	>0.5
<b>Quantity</b>	50 PCS/CTN



# LED WALL LIGHT



**WL2720A**

<b>Watt</b>	5W
<b>CCT Optional</b>	3000K
<b>Lumen</b>	120LM
<b>Voltage</b>	100-240V 50/60HZ
<b>CRI</b>	≥80
<b>IP</b>	IP65
<b>Beam angle</b>	60°
<b>Size</b>	120 X 42 X 32 MM
<b>P.F:</b>	>0.5
<b>Quantity</b>	50 PCS/CTN



**WL2720C**

<b>Watt</b>	4W
<b>CCT Optional</b>	3000K
<b>Lumen</b>	200LM
<b>Voltage</b>	100-240V 50/60HZ
<b>CRI</b>	≥70
<b>IP</b>	IP65
<b>Beam angle</b>	40°
<b>Size</b>	83X 123 X 30 MM
<b>P.F:</b>	>0.45
<b>Quantity</b>	50 PCS/CTN



**WL3450**

<b>Watt</b>	4W
<b>CCT Optional</b>	3000K
<b>Lumen</b>	260LM
<b>Voltage</b>	100-240V 50/60HZ
<b>CRI</b>	≥80
<b>IP</b>	IP65
<b>Beam angle</b>	0°~75°
<b>Size</b>	120 X 120 X 52 MM
<b>P.F:</b>	>0.45
<b>Quantity</b>	50 PCS/CTN

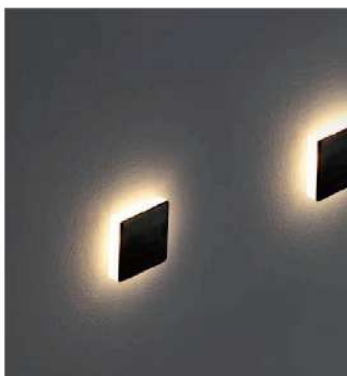
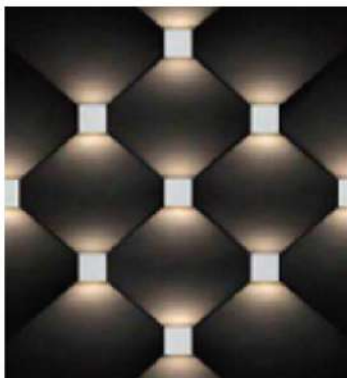

WALL LIGHT

# LED WALL LIGHT



**WL2760**

<b>Watt</b>	8W
<b>CCT Optional</b>	3000K
<b>Lumen</b>	400LM
<b>Voltage</b>	100-240V 50/60HZ
<b>CRI</b>	≥80
<b>IP</b>	IP65
<b>Beam angle</b>	120°
<b>Size</b>	200 X 100 X 31 MM
<b>P.F:</b>	>0.5
<b>Quantity</b>	50 PCS/CTN



**WL2780**

<b>Watt</b>	12W
<b>CCT Optional</b>	3000K
<b>Lumen</b>	630LM
<b>Voltage</b>	100-240V 50/60HZ
<b>CRI</b>	≥80
<b>IP</b>	IP65
<b>Beam angle</b>	120°
<b>Size</b>	300 X 100 X 31 MM
<b>P.F:</b>	>0.5
<b>Quantity</b>	50 PCS/CTN



WALL LIGHT

# LED WALL LIGHT



**WL3530A**

<b>Watt</b>	5W
<b>CCT Optional</b>	3000
<b>Lumen</b>	325LM
<b>Voltage</b>	100-240V 50/60HZ
<b>CRI</b>	≥80
<b>IP</b>	IP65
<b>Beam angle</b>	120°
<b>Size</b>	162 X 102 X 57 MM
<b>P.F:</b>	0.5
<b>Quantity</b>	50 PCS/CTN



**WL3530B**

<b>Watt</b>	10W
<b>CCT Optional</b>	3000K
<b>Lumen</b>	750LM
<b>Voltage</b>	100-240V 50/60HZ
<b>CRI</b>	≥80
<b>IP</b>	IP65
<b>Beam angle</b>	120°
<b>Size</b>	162 X 102 X 75 MM
<b>P.F:</b>	0.5
<b>Quantity</b>	50 PCS/CTN

# LED STEP LIGHT



**SL1111**

<b>Watt</b>	1W
<b>CCT Optional</b>	3000K
<b>Lumen</b>	80LM
<b>Voltage</b>	100-240V 50/60HZ
<b>CRI</b>	≥80
<b>IP</b>	IP65
<b>Beam angle</b>	75°
<b>Size</b>	70 X 50 X 12 MM
<b>P.F:</b>	>0.45
<b>Quantity</b>	50 PCS/CTN



**SL1112**

<b>Watt</b>	2W
<b>CCT Optional</b>	3000K
<b>Lumen</b>	85LM
<b>Voltage</b>	100-240V 50/60HZ
<b>CRI</b>	≥80
<b>IP</b>	IP20
<b>Beam angle</b>	75°
<b>Size</b>	90 X 12 X 120 MM
<b>P.F:</b>	>0.45
<b>Quantity</b>	50 PCS/CTN

# LED STEP LIGHT



**SL1532**

<b>Watt</b>	5W
<b>CCT Optional</b>	3000K
<b>Lumen</b>	350LM
<b>Voltage</b>	100-240V 50/60HZ
<b>CRI</b>	≥70
<b>IP</b>	IP65
<b>Beam angle</b>	110°
<b>Size</b>	230 X 80 X 28 MM
<b>P.F:</b>	0.45
<b>Quantity</b>	50 PCS/CTN



WALL LIGHT

# LED BULKHEAD LIGHT



**LBK130**

Watt	8W
CCT Optional	6500K
Lumen	560LM
Voltage	100-240V 50/60HZ
CRI	≥70
IP	IP65
Beam angle	120°
Size	163 X 73 X 41 MM
P.F:	>0.5
Quantity	50 PCS/CTN



**LBK140**

Watt	15W
CCT Optional	6500K
Lumen	990LM
Voltage	100-240V 50/60HZ
CRI	≥70
IP	IP65
Beam angle	120°
Size	200 X 100 X 48 MM
P.F:	>0.5
Quantity	50 PCS/CTN



WALL LIGHT

# SPOT LIGHT FIXTURE



**SLF127B**

**MODE:GU10**

Voltage	100-240V 50/60HZ
IP	IP65
Size	72 X 80 X 95 MM
Quantity	50 PCS/CTN

# LED SPIKE LIGHT



**SL110C**

Watt	5W
CCT Optional	3000K
Lumen	350LM
Voltage	100-240V 50/60HZ
CRI	≥80
IP	IP65
Beam angle	30°
Size	108 X 80 X 50 MM
P.F:	≥0.5
Quantity	50 PCS/CTN



**SL110D**

Watt	7W
CCT Optional	3000K
Lumen	490LM
Voltage	100-240V 50/60HZ
CRI	≥80
IP	IP65
Beam angle	30°
Size	108 X 80 X 50 MM
P.F:	≥0.5
Quantity	50 PCS/CTN

# LED SPIKE LIGHT



**SL120A**

<b>Watt</b>	5W
<b>CCT Optional</b>	3000K
<b>Lumen</b>	350LM
<b>Voltage</b>	100-240V 50/60HZ
<b>CRI</b>	≥80
<b>IP</b>	IP65
<b>Beam angle</b>	50°
<b>Size</b>	346 X 60 MM
<b>P.F:</b>	≥0.45
<b>Quantity</b>	50 PCS/CTN



**SL120B**

<b>Watt</b>	7W
<b>CCT Optional</b>	3000K
<b>Lumen</b>	490LM
<b>Voltage</b>	100-240V 50/60HZ
<b>CRI</b>	≥80
<b>IP</b>	IP65
<b>Beam angle</b>	55°
<b>Size</b>	346 X 60 MM
<b>P.F:</b>	>0.5
<b>Quantity</b>	50 PCS/CTN



**SL120C**

## MODE:GU10

<b>Voltage</b>	100-240V 50/60HZ
<b>CRI</b>	≥80
<b>IP</b>	IP65
<b>Size</b>	232 X 29 X 145 MM
<b>Quantity</b>	50 PCS/CTN

# LED SPIKE LIGHT



**SL230**

<b>Watt</b>	5W
<b>CCT Optional</b>	3000K
<b>Lumen</b>	410LM
<b>Voltage</b>	100-240V 50/60HZ
<b>CRI</b>	≥80
<b>IP</b>	IP65
<b>Beam angle</b>	70°
<b>Size</b>	50.7 X 50.7 X 207 MM
<b>P.F:</b>	≥0.5
<b>Quantity</b>	50 PCS/CTN



**SL230B**

<b>Watt</b>	5W
<b>CCT Optional</b>	3000K
<b>Lumen</b>	410LM
<b>Voltage</b>	100-240V 50/60HZ
<b>CRI</b>	≥80
<b>IP</b>	IP65
<b>Beam angle</b>	70°
<b>Size</b>	53 X 53 X 133 MM
<b>P.F:</b>	≥0.5
<b>Quantity</b>	50 PCS/CTN



WALL LIGHT



# LED SPIKE LIGHT



**SL1911**



Watt	1W
CCT Optional	3000K
Lumen	38LM
Voltage	100-240V 50/60HZ
CRI	≥60
IP	IP65
Beam angle	—
Size	150 X 140 X 280 MM
P.F:	—
Quantity	50 PCS/CTN



WALL LIGHT

# LED WALL LIGHT



**WL1907**



Watt	1W
CCT Optional	3000K
Lumen	80LM
Voltage	100-240V 50/60HZ
CRI	≥80
IP	IP44
Beam angle	80°
Size	236 X 85 MM
P.F:	—
Quantity	50 PCS/CTN





# LED RECHARGEABLE EMERGENCY LIGHT

With battery strength indicator

- 2 x 0.5 Watts LED BULB
- Charging time: 24 hrs
- With test switch
- Emergency time  
2 hours for double heads

**E 3001**  
**20 PCS/CTN**



- 2 x 1 Watts LED BULB
- Charging time: 24 hrs
- With on-off switch for each lamp
- With test switch
- With battery indicator
- Emergency time  
6 hours for double heads  
12 hours for single heads

**E 5229**  
**10 PCS/CTN**



- 2 x 1 Watts LED BULB
- Charging time: 24 hrs
- With on-off switch for each lamp
- With test switch
- With battery indicator
- Emergency time  
6 hours for double heads  
12 hours for single heads

**E 5039**  
**10 PCS/CTN**



EMERGENCY  
EQUIP.

# LED RECHARGEABLE EMERGENCY LIGHT

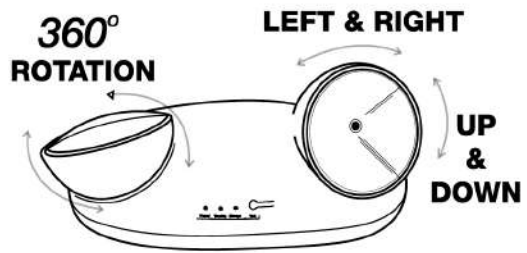

## N 955 LED WALL MOUNTED

Light source: 12PCS X 2.4W  
LED SUPER BRIGHT BUILT-IN  
Battery: 4V 2000MAh  
10 PCS/CTN



## N 577 LED WALL MOUNTED

2 X 1W LED BULB  
Emergency time:  
6 hours for double head  
Charging time: 24 hrs  
20 PCS/CTN

## N 950 LED WALL MOUNTED

Light source: 2 X 1W  
Battery: 6V 4Ah  
10 PCS/CTN



## N 859 LED WALL MOUNTED

Power: 2 X 2W  
Battery: 3.7V 2000mAH  
Emergency time: 2 hours  
Charging time: 24 hours  
20 PCS/CTN

# RECESSED TYPE LED EMERGENCY DISC

- Intelligent automatic recharging function
- Constant Current mode
- 3 Hour emergency operation
- Led charge star us display
- Test switch with self-test function
- Complete with Flex & Plug
- Easy installation

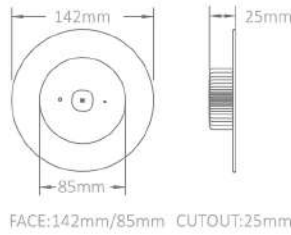

Description	Voltage	Watt	Dimensions	Cut-out Size	Charing Time	Duration Time	Quantity
OED	AC 220-240V	2W / 5W	Φ143 x 25mm	Φ73mm	24Hrs	2Hrs	10 pcs/ctn

# EMERGENCY LIGHT LED WHALE

- ES043
- 4kWh/1000h
- CON AUTO TEST



**LR-1003 IP20**

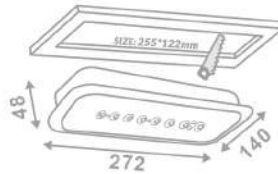

Description	Voltage	Watt	Lumen	CCT	Battery	Quantity
LR-1003	AC 170-265V 500/6Hz	4W	400LM	6500K	Ni-cd 3.6V 1200mAh	20 pcs/ctn

# EXIT LIGHT

**NX-01**



Description	Voltage	Watt	LED	Lead-Acid Battery	Dimensions	Recharge Time	Emergency Duration	Quantity
NX-01	220V 50/60Hz	1W	SMD	1.2V 600mAh	298 x 187 x 45mm	24Hrs	≥ 90mins	10 pcs/ctn

- ⚙️ LED LIGHTS
- ⌚ 2 HOURS OPERATING TIME
- 🔋 1.2V 300mAh
- ⚙️ 0.7W POWER
- ⌚ 24 HOURS CHARGING TIME
- 📦 Single or double sided



**EX-01** 20 PCS/CTN



**EX-02** 20 PCS/CTN



**EX-03** 20 PCS/CTN



**CX-01** 10 PCS/CTN

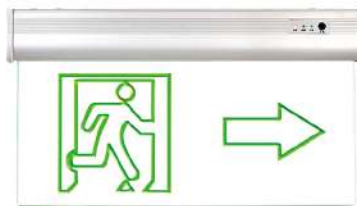

**CX-02** 10 PCS/CTN



**CX-03** 10 PCS/CTN

EMERGENCY EQUIP.

## INDUSTRIAL ALARM BELL HIGH INTENSITY SOUND FIRE ALARM BELL



Description	Size	Voltage	Quantity
AB-04 100MM	4"	AC220-240V	30 PCS/CTN
AB-06 150MM	6"	AC220-240V	20 PCS/CTN
AB-08 200MM	8"	AC220-240V	10 PCS/CTN
AB-10 250MM	10"	AC220-240V	10 PCS/CTN
AB-12 300MM	12"	AC220-240V	7 PCS/CTN
FB-04 100MM	4"	24V	30 PCS/CTN
FB-06 150MM	6"	24V	20 PCS/CTN



JGN-301A

## INDEPENDENT SMOKE DETECTOR

Operating current:	≤5uA
Alarm current:	≤7uA
Alarm sound:	3 meters ≥ 80 db
Protection area:	60m <sup>2</sup> -100m <sup>2</sup>
Product size:	Φ105x54 (including base)
Mounting hole spacing:	60mm
Product weight:	135g (including battery)
Quantity:	60 pcs/ctn



YT-102

## CONVENTIONAL SMOKE DETECTOR

Operating Voltage Range:	9 to 28 VDC Volts Non-polarized
Standby Current:	≤60μA@24VDC
Maximum Alarm Current:	≤30mA@24VDC (1K Ohm current-limiting resistance)
Operating Temperature Range:	-10°C to 50°C (14°F to 122°F)
Smoke Alarm Sensitivity:	0.15-0.3dB/m
Temperature Alarm Class:	A2R, 57°C (135°F)
Height:	55mm installed in Base
Diameter:	103 mm
Weight:	155g
Quantity:	60pcs/ctn

## INDEPENDENT HEAT DETECTOR

Sensor:	Thermistor.
Sensitivity:	57°C to 62°C.
Source:	Contains no radioactive material
Airspeed:	Essentially immune to the effect of airspeed.
Button Test:	Simulates the effect of heat and checks electronics and horn.
Supply Voltage:	9V battery.
Alarm:	Piezoelectric horn in unit.
Alarm Sound Output:	85dB (minimum) at 3m.
Temperature Range:	0 to 50°C.
Humidity Range:	15% to 95% Relative Humidity non condensing.
Fixing:	Screw fixings supplied.
Plastic material:	ABS, white.
Dimensions:	105mmx59 mm(DxH).
Weight:	177g.



IHD-311A

## CONVENTIONAL HEAT DETECTOR

Height:	2.2" (55 mm) installed in Base
Diameter:	4.0" (103 mm)
Weight:	5.5 oz. (155 g)
Installation Temperatures:	14°F to 122°F (-10°C to 50°C)
Operating Humidity Range:	10% to 93% Relative Humidity Non-condensing
Operating Voltage Range:	9 to 28VDC Volts Non-polarized
Standby Current:	40μA @ 24 VDC
Maximum Alarm Current (LED on: )	≤30mA @ 24 VDC
Fixed Temperature Rating:	135°F (57°C)



CHD-112

# MANUAL ALARM BUTTON FIRE SWITCH

## DAL-2

Features: High Intensity Sound  
Voltage: 220v  
Frequency: 60 Hz

### EASY TO OPERATE SIMPLE STRUCTURE

- Monitoring current: <240mA
- Alarm current: <2mA
- Wiring requirements: Signal bus BV line≥1.0mm
- Telephone communication line: RVS, ≥1.5mm<sup>2</sup>
- Quantity: 100pcs/ctn



# CONVENTIONAL MANUAL CALL POINT

The conventional manual call point designed for conventional fire alarm system for reporting fire or emergency condition by its PUSH IN/PULL DOWN handle latches. It is only used with conventional fire alarm control panel.

## MCF007

- Operating Voltage Range: 9 to 28VDC Volts
- Maximum Alarm Current (LED on): ≤50mA @ 24VDC
- Alarm Resistance: 470ohm/1W
- Operating Humidity Range: 10% to 93% Relative Humidity, Non-condensing
- Operating Temperature Range: -10°C to 50°C(14°F to 122°F)
- Dimensions: Length 140mm, Width 105mm, Depth 45mm
- Weight: Net Weight 220g
- Quantity: 50pcs/ctn



# CONVENTIONAL SOUNDER STROBE

The Sounder strobe is a kind of audible and visual alarm device installed in field, which can be activated by fire alarm control panel in fire control center or by manual call point installed in field. After activated, it will generate strong audible/audible and visual alarm signal to warn people in field. Three kind of sounds are optional.

## MCF008

- Working voltage: 9VDC-30VDC
- Alarm Current: ≤ 50mA.
- Ambient temperature: -10°C~+55°C
- Ambient humidity: ≤95%RH
- Sound level of alarm: ≥100dB
- Flash Intensity: ≥75CD
- Dimensions: 133mmX115mmX50mm(LxWxD(With base))
- Quantity: 60pcs/ctn
- Flash Period: ≤1S
- Life of flash light: >40000times
- Weight: 141g



# THERMAL SENSOR

## CAR 01

### FIRE OUT:

+24V-: 24VDC out put in the fire alarm status  
No,Nc,c: Relay contacts output in the fire alarm status.

### FAULT OUT:

No,Nc,c: Relay contacts output in the fault status.

**RS485:** Connect to the fire alarm panel with the twisted shield wires (RVSP type).

DC24V(IN+IN-): Power supply for repeater panel.

### EOF 120 OHM RESISTOR:

The last one repeater in the communication RS485 wire should set the JUMP JP2 to the position 1.



# CONVENTIONAL FIRE ALARM CONTROL PANEL

- 3.0 amps of system power.
- Each Zone can be disabled.
- Testing and disable functions.
- Sound output can be disabled.
- Manual active sound output enabled.
- Able to report short and broken circuit of detection zones.
- Panel Dimensions (mm)(L\*W\*D): 4 to 16 Zones: 370\*440\*100.
- One Form-A Alarm Relay, rouble elay and supervisory Relay.
- Panel Weight [Without Batteries]: 4 to16 Zones: 6.6kg /2 Zones: 2.2kg
- Can connect maximum 32 repeater panels by RS485 communication port.
- All zones accept conventional detectors and any normally open contact device.
- Designed with standby batteries and space provision for two sealed lead-acid batteries.
- Max 30 conventional detectors in one zone.
- Max 30 conventional detectors in one zone.
- Auto/Manual mode setting enable walk test.
- 2,4,8,16 Class B Initiating Device Circuits (IDCS).
- 1-4 Class B Notification Appliance Circuits (NACS).

EMERGENCY EQUIP.



**2 ZONES  
WITH 2 FREE  
DHB1240**

**CK1002**

**4 ZONES  
WITH 2 FREE  
DHB1240**

**CK1004**



**8 ZONES  
WITH 2 FREE  
DHB1270**

**CK1008**

**16 ZONES  
WITH 2 FREE  
DHB1270**

**CK1016**

# STORAGE BATTERY



**DHB 1240**

Battery size:	L91xW71xH100xTH105(MM)
Box size:	38.8x18.8 x12.1CM
Net weight:	1.29KGS
Quantity:	10 PCS/CTN
①Voltage:	12V
Capacity:	4AH
· Cycle use	
②Voltage:	14.4-15V
Initial Current:	less than 1.2A
· Float charging (STANDBY USE)	
③Voltage:	13.5-13.8V
· Charging current less than 1.2A	



**DHB 1270**

Battery size:	L151xW66xH95xTH100(MM)
Box size:	31.3x27.5 x12.6CM
Net weight:	2.0KGS
Quantity:	8 PCS/CTN
①Voltage:	12V
Capacity:	7AH
· Cycle use	
②Voltage:	14.4-15V
Initial Current:	less than 2.1A
· Float charging (STANDBY USE)	
③Voltage:	13.5-13.8V
· Charging current less than 2.1A	

# SPRINKLER



**MCF100**



**MCF011**



**MCF012**



**MCF013**

Description	Thread	K-factor	Glass ball diameter	Product size	Quantity
<b>MCF100</b>	45mm or R1/2	—	—	74 x 30.0mm	200PCS/CTN
<b>UPRIGHT -MCF011</b>	NPT1/2 or R1/2	K 5.6	Φ5mm	3.3 x 3.3 x 52.0mm	200PCS/CTN
<b>PENDENT -MCF012</b>	NPT1/2 or R1/2	K 5.6	Φ5mm	3.3 x 3.3 x 51.6mm	200PCS/CTN
<b>SIDEWALL -MCF013</b>	NPT1/2 or R1/2	K 5.6	Φ5mm	3.3 x 3.3 x 65.5mm	200PCS/CTN



EMERGENCY EQUIP.

# Conventional Fire Alarm System

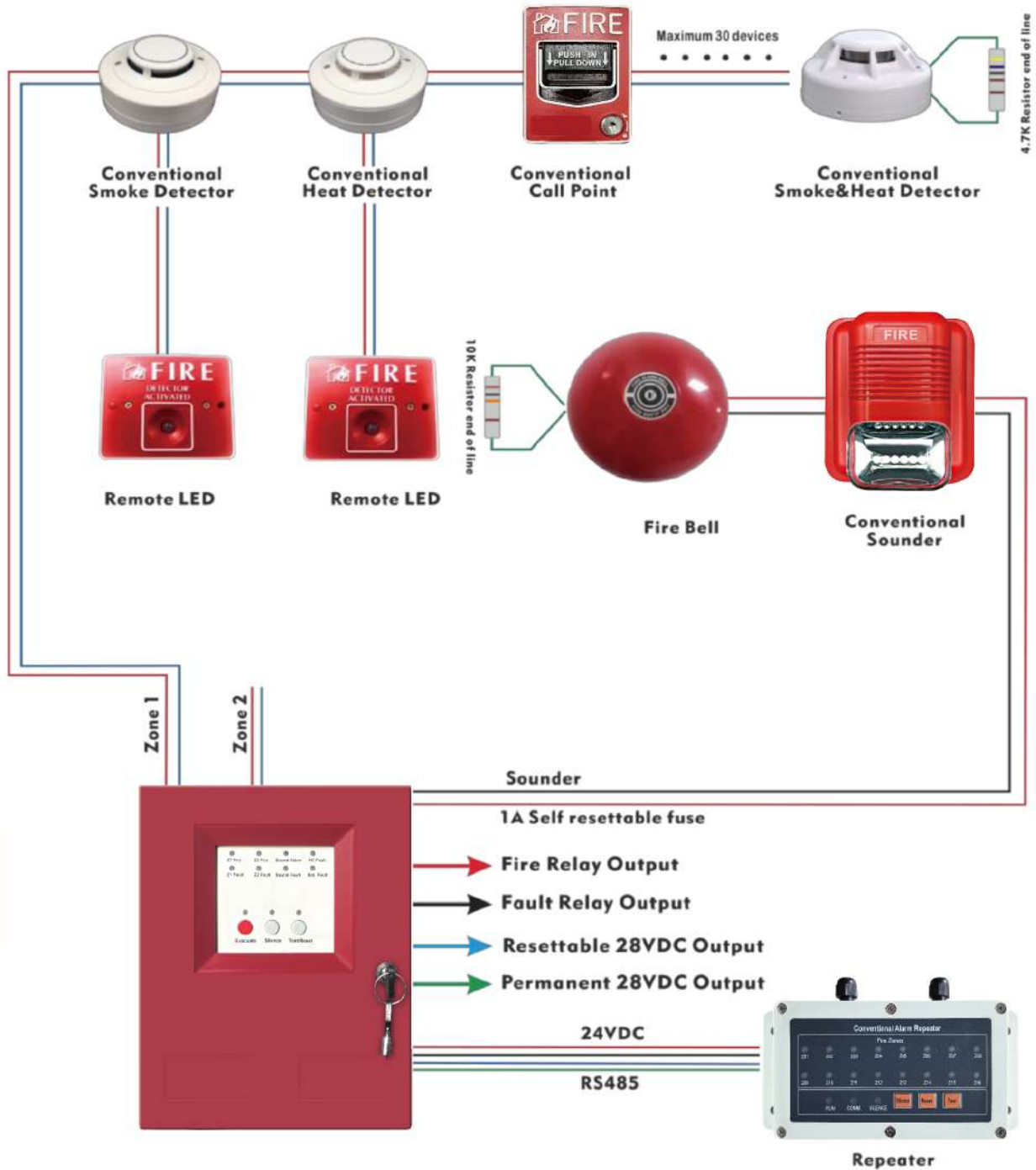

2 Zones Conventional Fire Alarm Control Panel

Focus on your safety, your strongest security partner .

# LED FLOOD LIGHT

- More environmentally,energy-saving!
- Proof thickened aluminum supercooling.
- Proof glass lens perspective is very strong.
- Product of green environmental protection energy saving and high efficiency.
- Fine workmanship real materials.



ZDL3027



YTMF-1005



GKP

Description	Voltage	Watt	LED	P.F:	Lumen	CRI	CCT	Dimensions	Quantity
ZDL3027	160-265V	10W	SMD	0.9	900LM	≥80	6500k	100 x 75 x 23 mm	40 pcs/ctn
	160-265V	20W	SMD	0.9	2200LM	≥80	6500k	119.9 x 110.7 x 27.5 mm	40 pcs/ctn
	160-265V	30W	SMD	0.9	2700LM	≥80	6500k	180 x 130 x 23 mm	20 pcs/ctn
	160-265V	50W	SMD	0.9	5500LM	≥80	6500k	187.9 x 165.1 x 31.8 mm	10 pcs/ctn
	160-265V	100W	SMD	0.9	11000LM	≥80	6500k	242.3 x 202.9 x 33.6 mm	8 pcs/ctn
	160-265V	150W	SMD	0.9	16500LM	≥80	6500k	279.4 x 230 x 35.4 mm	6 pcs/ctn
	160-265V	200W	SMD	0.9	22000LM	≥80	6500k	328.8 x 275.5 x 37.4 mm	5 pcs/ctn
	160-265V	300W	SMD	0.9	33000LM	≥80	6500k	378.9 x 312.4 x 45.1 mm	4 pcs/ctn

Description	Voltage	Watt	LED	P.F:	Lumen	CRI	CCT Optional	Dimensions	Quantity
YTMF-1005	170-240V	100W	SMD	0.9	9200LM	≥80	3000-6500k	391.1 x 316.8 x 94.5mm	5 pcs/ctn
	170-240V	150W	SMD	0.9	13500LM	≥80	3000-6500k	391.1 x 316.8 x 94.5mm	5 pcs/ctn
	170-240V	200W	SMD	0.9	16780LM	≥80	3000-6500k	199 x 370 x 105mm	2 pcs/ctn

Description	Voltage	Watt	LED	P.F:	Lumen	CRI	CCT	Dimensions	Quantity
GKP	120-277V	100W	SMD	0.9	15000LM	≥80	6500k	269.2 x 306.4 x 50 mm	5 pcs/ctn
	120-277V	150W	SMD	0.9	22500LM	≥80	6500k	319.6 x 369.6 x 54 mm	5 pcs/ctn
	120-277V	200W	SMD	0.9	30000LM	≥80	6500k	353.7 x 403.8 x 57 mm	5 pcs/ctn
	120-277V	300W	SMD	0.9	45000LM	≥80	6500k	401.2 x 450 x 60 mm	5 pcs/ctn

# DIAMOND FLOOD LIGHT

ZDL3023



- 10kV surge protection
- Long-lasting aluminum housing
- Excellent thermal management for stable performance
- Long lifespan, low maintenance cost



Description	Voltage	Watt	LED	P.F.	Lumen	CRI	CCT	Size	Quantity
ZDL3023	85-277V	50W	SMD2835	0.92	6500LM	≥80	6500k	247 x 237 x 47mm	10 pcs/ctn
ZDL3023	85-277V	100W	SMD2835	0.92	13000LM	≥80	6500k	301 x 280 x 55mm	5 pcs/ctn
ZDL3023	85-277V	150W	SMD2835	0.92	19500LM	≥80	6500k	358 x 320 x 61mm	5 pcs/ctn
ZDL3023	85-277V	200W	SMD2835	0.92	26000LM	≥80	6500k	412 x 366 x 63mm	4 pcs/ctn
ZDL3023	85-277V	250W	SMD2835	0.92	32500LM	≥80	6500k	486 x 406 x 69mm	3 pcs/ctn
ZDL3023	85-277V	300W	SMD2835	0.92	39000LM	≥80	6500k	486 x 406 x 69mm	3 pcs/ctn



# DIE CAST LENS VERSION PROJECTOR



ZDL3028

Description	Voltage	Watt	LED	P.F.	Lumen	CRI	CCT	Package Size	Quantity
ZDL3028	160-265V	100W	SMD2835	0.5	12000LM	≥80	6500k	336x282x261mm	8 pcs/ctn
ZDL3028	160-265V	150W	SMD2835	0.5	18000LM	≥80	6500k	328x232x299mm	5 pcs/ctn
ZDL3028	160-265V	200W	SMD2835	0.5	24000LM	≥80	6500k	370x240x320mm	5 pcs/ctn
ZDL3028	160-265V	300W	SMD2835	0.9	36000LM	≥80	6500k	455x440x390mm	5 pcs/ctn

# TUNNEL LIGHT

ZDL1187



- Die cast radiator: excellent thermal management and compact structure
- Single module 50W/60W, up to 5 modules 500W/600W
- Optimized layout of embedded cable ducts
- IK08 tempered glass cover can be used under harsh conditions
- Accurate installation of rack angle up to 270°
- 4mm thick L-shaped support with wind resistance rate of 17
- Light metering: symmetrical 30°/45°/60°/90°, asymmetric 150°\*80°/120°\*90°
- Widely used in ports, docks, tower cranes, stadiums, etc



Description	Voltage	Watt	LED	P.F.	Lumen	CRI	CCT	Size	Quantity
ZDL1187	85-277V	50W	SMD2835	0.95	7000LM	≥80	6500k	133 x 372 x 97mm	1 pc/ctn
ZDL1187	85-277V	100W	SMD2835	0.95	14000LM	≥80	6500k	133 x 372 x 97mm	1 pc/ctn
ZDL1187	85-277V	150W	SMD2835	0.95	21000LM	≥80	6500k	220 x 372 x 97mm	1 pc/ctn
ZDL1187	85-277V	200W	SMD2835	0.95	28000LM	≥80	6500k	310 x 372 x 97mm	1 pc/ctn
ZDL1187	85-277V	250W	SMD2835	0.95	35000LM	≥80	6500k	398 x 372 x 97mm	1 pc/ctn
ZDL1187	85-277V	300W	SMD2835	0.95	42000LM	≥80	6500k	486 x 372 x 97mm	1 pc/ctn

FLOOD LIGHT / SOLAR LIGHT

# LED MINING LIGHT

## ZDXL1811



Description	Voltage	Watt	LED	P.F.	Lumen	CRI	CCT	Package Size	Quantity
ZDXL1811	160-265V	100W	SMD2835	0.9	12000LM	≥80	6500k	625x285x300mm	5 pcs/ctn
	160-265V	150W	SMD2835	0.9	18000LM	≥80	6500k	625x340x330mm	5 pcs/ctn
	160-265V	200W	SMD2835	0.9	24000LM	≥80	6500k	385x345x360mm	5 pcs/ctn
	160-265V	300W	SMD2835	0.9	36000LM	≥80	6500k	405x385x400mm	5 pcs/ctn

## ZDXL1812



Description	Voltage	Watt	Driver	P.F.	Lumen	CRI	CCT	Package Size	Quantity
ZDXL1812	100-277V	100W	Philip	>0.9	16000LM	80	6500k	Φ250 x 143mm	8 pcs/ctn
	100-277V	200W	Philip	>0.9	32000LM	80	6500k	Φ320 x 147mm	6 pcs/ctn

# HIGH BAY COVER

Watt  
100W  
200W



FLOOD LIGHT /  
SOLAR LIGHT

# MINING LAMP



**GDXL1033**



**ZDL1183**

Description	Voltage	Watt	LED	P.F.	Lumen	CRI	CCT	Size	Quantity
<b>GDXL1033</b>	85-277V	100W	SMD2835	0.95	15000LM	≥80	6500k	248 x 129 mm	1 pc/ctn
	85-277V	150W	SMD2835	0.95	22500LM	≥80	6500k	295 x 140 mm	1 pc/ctn
	85-277V	200W	SMD2835	0.95	30000LM	≥80	6500k	320 x 154 mm	1 pc/ctn
	85-277V	240W	SMD2835	0.95	36000LM	≥80	6500k	320 x 154 mm	1 pc/ctn

Description	Voltage	Watt	LED	P.F.	Lumen	CRI	CCT	Size	Quantity
<b>ZDL1183</b>	85-277V	400W	SMD2835	0.95	56000LM	≥80	6500k	493 x 439 x 421mm	1 pc/ctn
	85-277V	500W	SMD2835	0.95	70000LM	≥80	6500k	493 x 439 x 421mm	1 pc/ctn
	85-277V	800W	SMD2835	0.95	112000LM	≥80	6500k	651 x 586 x 511mm	1 pc/ctn
	85-277V	1000W	SMD2835	0.95	140000LM	≥80	6500k	651 x 586 x 511mm	1 pc/ctn



FLOOD LIGHT / SOLAR LIGHT

# STREET LIGHT

RCP



## PHOTO CONTROL SWITCH

Description	Voltage	Quantity
PCW	AC 220V-6A	70 PCS/CTN

Description	Voltage	Watt	LED	P.F.	Lumen	CRI	CCT	Dimensions	Quantity
RCP	160-265V	50W	SMD2835	0.9	6000LM	≥80	6500k	120x 456x 83mm	5 pcs/ctn
	160-265V	100W	SMD2835	0.9	12000LM	≥80	6500k	144x 527x 83mm	5 pcs/ctn
	160-265V	200W	SMD2835	0.9	24000LM	≥80	6500k	193x 625x 85mm	5 pcs/ctn

# RECHARGEABLE WORK LIGHT



TGE



Description	Watt	Lumen	CCT	Battery	LED	Dimensions	Quantity
TGE	50W	1000LM	6500K	3.2V/8Ah LiFeO4	92pcs 2835	254.9 x 326.4 x 56.8 mm	6 pcs/carton

# SOLAR PROJECTOR

Working environment: outdoor, facing south, no shelter, direct sunlight.

TK-LT



FLOOD LIGHT / SOLAR LIGHT

Description	Watt	Lumen	CCT	Battery	LED	Quantity	Charging time	Discharging time
TK-LT	30W	400LM	6500K	3.2V/5Ah LiFeO4	45pcs 2835	14 pcs/carton	6-8 Hours	12 Hours
TK-LT	50W	700LM	6500K	3.2V/5Ah LiFeO4	66pcs 2835	7 pcs/carton	6-8 Hours	12 Hours
TK-LT	100W	1100LM	6500K	3.2V/10Ah LiFeO4	84pcs 2835	5 pcs/carton	6-8 Hours	12 Hours
TK-LT	200W	1400LM	6500K	3.2V/15Ah LiFeO4	170pcs 2835	5 pcs/carton	6-8 Hours	12 Hours
TK-LT	300W	2000LM	6500K	3.2V/25Ah LiFeO4	273pcs 2835	3 pcs/carton	6-8 Hours	12 Hours

# SOLAR PROJECTOR WITH REMOTE CONTROL

ZDL3012S



Description	Voltage	Watt	LED	P.F:	CRI	CCT optional	Lamp size	Solar panel size	Quantity
ZDL3012S	170-240V	50W	SMD2835	0.9	≥70	6500k	192 x 132 x 41mm	350 x 230 x 17mm	5 pcs/ctn
ZDL3012S	170-240V	150W	SMD2835	0.9	≥70	6500k	254 x 173 x 41mm	350 x 350 x 17mm	5 pcs/ctn
ZDL3012S	170-240V	300W	SMD2835	0.9	≥70	6500k	285 x 198 x 41mm	350 x 530 x 17mm	5 pcs/ctn



TKP



TBP

## SOLAR GARDEN LIGHT



Description	Watt	Lumen	CCT	Battery	LED	Dimensions	Quantity
TKP	100W	400LM	3000k/4000k/6500k	3.2V/2.5Ah LiFeO4	48pcs 2835	194 x 102 x 50 mm	20 pcs/carton

Description	Watt	Lumen	CCT	Battery	LED	Dimensions	Quantity
TBP	50W	400LM	3000k/4000k/6500k	3.2V/5Ah LiFeO4	122pcs 2835	Φ257.1x207.8mm	6 pcs/carton

# SOLAR ENERGY LED STREET LIGHT

## IP66 CE ROHS

Work hours: Whole night.  
 The first four hours 100% lumen, the rest hours lumen drop gradually.  
 Installation height: 8-10meters  
 Installation distance: 35-45meters  
 Charging time: 8hours  
 Installation time: 16hrs Warranty: 5years



SOL-20S/SOL-30S



SOL-60S

LTEM		SOLAR PANEL		LED LIGHT			BATTERY	
Description	Watt	Power	Size	Lumen	Size	Life span	U/I	Type
SOL-20S	20W	5V/25W	535x350x27mm	1400lm	495x210x80mm	50000hrs	3.2V/20Ah	LiFePO4
SOL-30S	30W	10V/45W	535x350x27mm	2300lm	495x210x80mm	50000hrs	6.4V/30Ah	LiFePO4
SOL-60S	60W	5V/65W	670x603x30mm	3300lm	650x206x63mm	50000hrs	3.2V/50Ah	LiFePO4

FLOOD LIGHT / SOLAR LIGHT

# SOLAR STREET LIGHT



SOL



ZDLS-3002



ZDLS-3005



TRE



TRE-50W

Description	Watt	Solar Panel	LED	CCT Optional	Lumen	Material	Charging Time	Discharging Time	Quantity
SOL	30W	6V / 8W	SMD5730	3000/6500k	800lm	ABS	4 Hours	12-16 Hours	10 pcs/ctn
	60W	6V / 10W	SMD5730	3000/6500k	10000lm	ABS	4 Hours	12-16 Hours	6 pcs/ctn
	90W	6V / 15W	SMD5730	3000/6500k	12000lm	ABS	4 Hours	12-16 Hours	4 pcs/ctn

Description	Watt	CRI	CCT	Lumen	Battery	Solar Panel	Product Size	Quantity
ZDL-3002	30W	>70	6500k	500lm	3.2V / 5AH	5V / 6W	360 x187 x55 mm	10 pcs/ctn
	50W	>70	6500k	800lm	3.2V / 10AH	5V / 9W	478 x190 x55 mm	10 pcs/ctn
	70W	>70	6500k	1000lm	3.2V / 12AH	5V / 11W	600 x197 x55 mm	10 pcs/ctn
	100W	>70	6500k	1300lm	3.2V / 15AH	5V / 13W	630 x250 x70 mm	6 pcs/ctn

Description	Watt	CRI	CCT	Beam Angle	Lumen	Battery	Solar Panel	Overall Lamp Size	Quantity
ZDL-3005	100W	>70	6500k	75°x135°	850lm	3.7V/10AH	5V/10W	461x175x47mm	10 pcs/ctn
	200W	>70	6500k	75°x135°	1700lm	3.7V/20AH	5V/20W	588x251x45mm	10 pcs/ctn
	300W	>70	6500k	75°x135°	2550lm	3.7V/30AH	5V/30W	753x266x46mm	10 pcs/ctn

Description	Watt	Lumen	CCT	Battery	Solar Panel	LED	Quantity
TRE	50W	350LM	6500K	3.7V/3Ah LiFeO4	6V 3W	143pcs 2835	10 pcs/carton
	200W	650LM	6500K	3.2V/5Ah LiFeO4	6V 6W	112pcs 2835	5 pcs/carton
	300W	1350LM	6500K	3.2V/10Ah LiFeO4	6V 10W	168pcs 2835	5 pcs/carton
	400W	2000LM	6500K	3.2V/15Ah LiFeO4	6V 15W	224pcs 2835	5 pcs/carton

FLOOD LIGHT / SOLAR LIGHT

## INTEGRATED LEADLESS NEON STRIP LIGHT



### RX 01

### SMD2835 CHIP

Voltage	220V
LED type	SMD2835 Chip 120pcs
CRI	≥70Ra
Lumen	120lm/led(40lm/meters)
Dimension	8 X 16mm
FPC size	6MM
Power factor	7W/M
Beam angel	120°
Life time	20000Hours
Protection class	IP65
Package	50m/roll
Color tempreure	3000K / 4000K / 6000K

Color tempreure Red / Golden / Green / Pink / Blue / Purple / Orange



**RX-P01**  
POWER CORD



**RX-E02**  
END CUP



**RX-C03**  
FIXING CLAMP



**RX-M04**  
MIDDLE CONNECTOR



**RX-PIN**  
NEEDLE PIN CONNECTOR



## INTEGRATED LEADLESS STRIP LIGHT

### EH 268

### EF-JC2835-60D-8MM

Voltage	220V
LED type	SMD2835 Chip 60PCS
CRI	≥70Ra
Lumen	20-22lm/led(280lm/meter)
Dimension	13.8 X 6mm
FPC size	8mm
Power factor	7W/M
Beam angel	120°
Life time	20000Hours
Protection class	IP65
Package	50m/roll
Color tempreure	3000K / 4000K / 6500K

Color tempreure Blue / Green / Red / Golden / Pink

### EH 21210 EF-JC2835-120D-10MM

Voltage	220V
LED type	SMD2835 Chip 120PCS
CRI	≥70Ra
Lumen	20-22lm/led(620lm/meter)
Dimension	13.8 X 6mm
FPC size	10mm
Power factor	11W/M
Beam angel	120°
Life time	20000Hours
Protection class	IP65
Package	50m/roll
Color tempreure	3000K / 4000K / 6500K



# INTEGRATED LEADLESS STRIP LIGHT



**PC02**  
INTEGRATED  
POWER CORD  
220V-10A-10MM  
-WATERPROOF



## EH 5610

EF-JC5050-60D-10MM

Voltage	220V
LED type	SMD5050 Chip 60PCS
CRI	≥70Ra
Lumen	20-22lm/led(300lm/meter)
Dimension	13.8 X 6mm
FPC size	10mm
Power factor	7W/M
Beam angel	120°
Life time	20000Hours
Protection class	IP65
Package	50m/roll
Color tempereure	3000K / 4000K / 6500K

## EH 2912-C

EF-JC2835 120D-12MM

Voltage	220V
LED type	SMD2835 Chip 120PCS
CRI	≥70Ra
Lumen	20-22lm/led(240lm/meter)
Dimension	16 X 6mm
FPC size	12mm
Power factor	8W/M
Beam angel	120°
Life time	20000Hours
Protection class	IP65
Package	50m/roll
Color tempereure	6500K+3000K / 3000K+Blue



## C03

DIMMER CONTROLLER  
POWER CORD W / BUTTON  
12MM  
INTEGRATED  
2-COLOR DIMMABLE



## RH 5612

EF-JC5050 60D-12MM RGB PVC

Voltage	220V
LED type	SMD5050 Chip 60PCS
CRI	≥70Ra
Lumen	20-22lm/led(110lm/meter)
Dimension	16 X 6mm
FPC size	12mm
Power factor	8W/M
Beam angel	120°
Life time	20000Hours
Protection class	IP65
Package	50m/roll
Color tempereure	RGB



## RC-04

RGB CONTROLLER  
12MM  
INTEGRATED RGB BUTTON



## RC-04/1

RGB CONTROLLER WITH REMOTE  
12MM  
INTEGRATED RGB REMOTE

### COB 288

#### COB-280D-8MM WHITE

Voltage	220V
LED type	COB Chip 280PCS
CRI	≥70Ra
Lumen	600 lm/meter
FPC size	8mm
Power factor	8W/M
Beam angel	120°
Life time	20000Hours
Protection class	IP65
Package	50m/roll
Color temprature	3000K / 4000K / 6500K

## LED STRIP HIGH BRIGHT



### CB-02

**COB POWER PLUG**  
220V-10A-8MM  
100 PCS/CTN

## INTEGRATED WIRELESS STRIP LIGHT

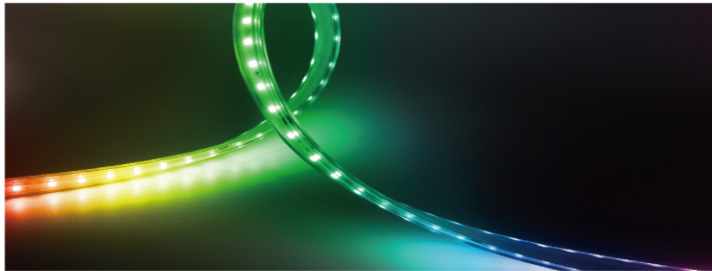

### EJ 268

#### EH-JC-2835-60D-8MM

Voltage	220V
Roll length	5000(L) x 7(W) x 4(T) mm
Power factor	7W/M
Service life	10000Hours
Ingress protection	IP65 (waterproof)
Box size	62 x 23.5 x 25.5 cm
Package	20 pcs/ctn
Color temprature	3000K / 4000K / 6000K / RED / GOLDEN / GREEN / PINK / BLUE / PURPLE / ORANGE

## 12V-24V POWER SUPPLY CIV-01

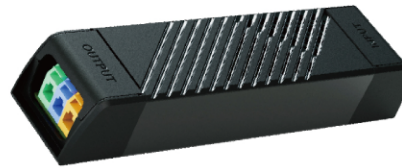

Power	Input Voltage	P.F.	Output voltage automatic recognition	Description	Output Current	Quantity
100W	180-265V	0.6	12/24V	159.8 x 39 x 29mm	7.0A 3.3A	80 pcs/ctn
150W	180-265V	0.6	12/24V	159.8 x 46 x 29mm	9.0A 5.0A	60 pcs/ctn
200W	180-265V	0.6	12/24V	178.7 x 46 x 29mm	11.5A 6.6A	50 pcs/ctn
300W	180-265V	0.6	12/24V	199.8 x 53 x 32mm	15.0A 10.0A	36 pcs/ctn
400W	180-265V	0.6	12/24V	219.7 x 53 x 32mm	20.0A 13.3A	36 pcs/ctn

## LED STRIP HIGH BRIGHT



Home decoration, Suitable for Aluminum profile



### BC 2128

#### B-JC-2835-120D-8MM-5CM/CUT

Voltage	24V
LED type	SMD2835 Chip 120PCS
CRI	≥80Ra
Lumen	21-23lm/led(950 lm/meter)
FPC size	8mm
Power factor	10W/M
Beam angel	120°
Life time	20000Hours
Protection class	IP20
Package	10m/roll 50roll/ctn
Color temprature	3000K / 4000K / 6500K

Color temprature Red / Green / Blue / Golden / Pink / Purple / Orange / ICE Blue

## LOW VOLTAGE STRIP



### COB 32128 COB-320D-12V-8MM

Voltage	12V
LED type	COB Chip 320PCS
CRI	≥80Ra
Lumen	1330 lm/meter
FPC size	8mm
Power factor	4W/M
Beam angel	120°
Life time	20000Hours
Protection class	IP20
Package	5m/roll
Color tempreure	3000K / 4000K / 6500K

## INTEGRATED LEADLESS STRIP LIGHT

### RH 5612 2835/54D- 8MM

Voltage	12V
LED type	2835/54D
CRI	70Ra
Dimension	5000(L)X8(W)X2(T)mm
FPC size	8mm
Power factor	12W/M
Beam angel	120°
Life time	10000Hours
Protection class	IP44
Package	5m/roll
Quantity	20 pcs/ctn
Color tempreure	RGB



### NL 268

#### EF-JC2835 60D-8MM BARE BOARD (50M)

Voltage	DC12V
LED type	SMD2835 Chip 60PCS
CRI	≥70Ra
Lumen	20-22lm/led(630lm/meter)
Dimension	8 X 3mm
FPC size	8mm
Power factor	9.6W/M
Beam angel	120°
Life time	20000Hours
Protection class	IP20
Package	50m/roll
Color tempreure	3000K / 4000K / 6000K



### NL 268

#### EF-JC2835 60D-8MM BARE BOARD (200M)

Voltage	DC12V
LED type	SMD2835 Chip 60PCS
CRI	≥70Ra
Lumen	20-22lm/led(630lm/meter)
Dimension	8 X 3mm
FPC size	8mm
Power factor	9.6W/M
Beam angel	120°
Life time	20000Hours
Protection class	IP20
Package	200m/roll
Color tempreure	3000K / 6000K

### NL 5610

#### EF-JC5050 60D-10MM

Voltage	DC12V
LED type	SMD5050 Chip 60PCS
CRI	≥70Ra
Lumen	20-22lm/led(280lm/meter)
Dimension	5 X 12mm
FPC size	10mm
Power factor	9.6W/M
Beam angel	120°
Life time	20000Hours
Protection class	IP20
Package	50m/roll
Color tempreure	3000K / 4000K / 6500K

### NL 5610

#### EF-JC5050 60D-10MM

Voltage	DC12V
LED type	SMD5050 Chip 60PCS
CRI	≥70Ra
Lumen	20-22lm/led(280lm/meter)
Dimension	5 X 12mm
FPC size	10mm
Power factor	9.6W/M
Beam angel	120°
Life time	20000Hours
Protection class	IP20
Package	200m/roll
Color tempreure	3000K / 6500K



**NL/P60W**  
DRIVER POWER  
-12V , IP20 ,  
FOR BARE BOARD

STRIP LIGHT /  
STRING LIGHT

# INTEGRATED LEADLESS STRIP LIGHT



## SL 268

EF-JC2835 60D-8MM SILICON MOLDING

Voltage	DC12V
LED type	SMD2835 Chip 60PCS
CRI	≥70Ra
Lumen	20-22lm/led(600lm/meter)
Dimension	5 X 12mm
FPC size	8mm
Power factor	9.6W/M
Beam angel	120°
Life time	20000Hours
Protection class	IP65
Package	50m/roll
Color temprure	3000K / 4000K / 6500K



**SL/P60W**  
DRIVER POWER  
-12V-60W , IP66  
FOR SILICONE

## DL 268

EF-JC2835-60D-8mm-Dripping Glue

Voltage	DC 12V
LED type	SMD2835 Chip 60PCS
CRI	≥70Ra
Lumen	20-22lm/led(600lm/meter)
Dimension	8 X 3mm
FPC size	8mm
Power factor	7W/M
Beam angel	120°
Life time	20000Hours
Protection class	IP44
Package	5m/Set
Color temprure	3000K / 4000K / 6500K

## DL 5610

EF-JC5050-60D-10mm-Dripping Glue

Voltage	DC 12V
LED type	SMD5050 Chip 60PCS
CRI	≥70Ra
Lumen	20-22lm/led(600lm/meter)
Dimension	8 X 3mm
FPC size	10mm
Power factor	7W/M
Beam angel	120°
Life time	20000Hours
Protection class	IP44
Package	5m/Set
Color temprure	3000K / 4000K / 6500K



Highlight chip  
Bright color



Copper core wire  
Stable performance



Anti-bad lamp  
bead design  
Peace of mind



High light  
transmission silicone  
Bright color



Flexible soft board  
Arbitrarily



Smart chip  
Choose what  
you need



Sunlight color  
Naturally soft



Feel free to  
install  
Easy to operate



STRIP LIGHT /  
STRING LIGHT

**NEON ROPE STRIP LIGHT  
RGB**



**NRL-30L NEON ROPE STRIPLIGHT RGB**

Voltage	5V
LED type	SMD5050 Chip 30PCS
CRI	≥50Ra
Lumen	43.7Lm/m
Dimension	7 X 15mm
FPC size	7mm
Power factor	5W/M
Beam angel	120°
Life time	6000Hours
Protection class	IP65
Package	5m/roll
Color tempreure	Magic RGB

**LED ROPE  
STRING LIGHT**

**STL-20L LED ROPE STRING LIGHT**

Voltage	5V
LED type	SMD2025 Chip 100PCS
Dimension	8mm
Power factor	4.5W/M
Beam angel	≥360°
Life time	8000Hours
Protection class	IP65
Package	5m/roll
Color tempreure	6500K+3000K



**FLEXIBLE TUBE LED  
STRIPLIGHT 6 COLORS**



**CL-6 FLEXIBLE TUBE LED STRIPLIGHT-6 COLORS**

Voltage	220V
LED type	SMD2835 Chip 48PCS
CRI	≥80Ra
Lumen	44.6Lm/m
Dimension	3.8 X 8.2mm
FPC size	7mm
Power factor	3W/M
Beam angel	120°
Life time	6000Hours
Protection class	IP65
Package	5m/roll
Color tempreure	Six colors

STRIP LIGHT /  
STRING LIGHT

# LED STRIP ACCESSORIES



**E02**  
END CUP  
220V-10MM



**S02**  
SILICONE END CUP  
12V/24V-15CM



**P02**  
FIXING CLAMP  
220V-10MM



**CO-01**  
COB END CUP  
220V-10MM  
100 PCS/CTN



**CO-02**  
COB FIXING CLAMP  
220V-10MM  
100 PCS/CTN



**M02**  
MIDDLE CONNECTOR  
10MM 2PIN



**M03**  
MIDDLE CONNECTOR  
10MM 3PIN



**M04 (RGB)**  
MIDDLE CONNECTOR  
10MM 4PIN

Reel+Anti-static bag(one set)



**RB-001**  
Reel: H 1cm  $\Phi$ 13cm,  
for 5 meters strip IP20  
Bag: 21 X 19cm

Reel+Anti-static bag(one set)



**RB-002**  
Reel: H 1cm  $\Phi$ 13cm,  
for 5 meters strip IP20  
Bag:25 X 26 cm



**W02**  
CONNECTING WIRE  
12V/24V-15CM



**NL/M-01S**  
CONNECTOR WIRE  
8MM



**NL/M-01D**  
CONNECTOR WIRE  
8MM



**NL/M-02S**  
CONNECTOR WIRE  
10MM



**NL/M-02D**  
CONNECTOR WIRE  
10MM



**WL-1509B**  
ALUMINUM TROUGH  
100 PCS/CTN  
1M  
3M



**WL-1707B**  
ALUMINUM TROUGH  
100 PCS/CTN  
1M  
3M

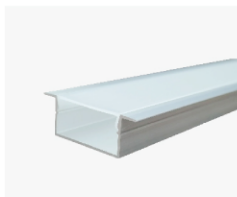

**WL-2010B**  
ALUMINUM TROUGH  
100 PCS/CTN  
1M  
3M



**WL-1616**  
ALUMINUM TROUGH  
100 PCS/CTN  
1M  
3M

# STRING LIGHT STRL-01



Description	Watt	Voltage	Length	CCT	CAP	Lumen	CRI	Beam Angle	Quantity
STRL-01	1W x 10	220-240V/50Hz	30FT	2700k	E27	60LM	≥80	360°	6 BOXES/CTN

# CHRISTMAS LED LIGHT RL2C



WHITE ○ WARM WHITE ○ RED ● BLUE ●  
 GREEN ● PINK ●

Model	Voltage	LED QTY	Length	Power	Max. Connecting	Quantity
<span style="background-color: #f4a460; padding: 2px 5px; border-radius: 5px;">RL5M</span>	230V/50Hz	50	5m	3.2W	40 PCS	20 PCS/CTN
<span style="background-color: #4a90e2; padding: 2px 5px; border-radius: 5px;">RL10M</span>	230V/50Hz	100	10m	6.5W	20 PCS	20 PCS/CTN

RGB

Model	Voltage	LED QTY	Length	Power	Max. Connecting	Quantity
<span style="background-color: #f4a460; padding: 2px 5px; border-radius: 5px;">RL5M-RGB</span>	230V/50Hz	50	5m	4.6W	40 PCS	20 PCS/CTN
<span style="background-color: #4a90e2; padding: 2px 5px; border-radius: 5px;">RL10M-RGB</span>	230V/50Hz	100	10m	9.2W	20 PCS	20 PCS/CTN

FOUR-COLOR

Model	Voltage	LED QTY	Length	Power	Max. Connecting	Quantity
<span style="background-color: #f4a460; padding: 2px 5px; border-radius: 5px;">RL5M-4C</span>	230V/50Hz	50	5m	6.5W	35 PCS	20 PCS/CTN
<span style="background-color: #4a90e2; padding: 2px 5px; border-radius: 5px;">RL10M-4C</span>	230V/50Hz	100	10m	6.5W	20 PCS	20 PCS/CTN

STRIP LIGHT / STRING LIGHT

# CHRISTMAS LED LIGHT SMD2025

Advantage:

\*Copper wire with PVC coating

\*Ultra Soft for different shapes

\*UV glue & Eco-friendly PVC

\*Works for Wedding Centerpiece, Party, Christmas, Halloween & Table Decor

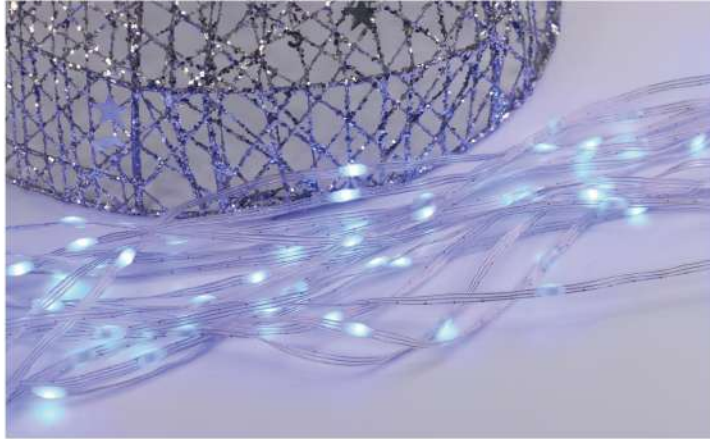

BATTERY BOX & CONTROLLER



USB PLUG & CONTROLLER



SOLAR POWER & REMOTE CONTROL



ADAPTOR & CONTROLLER

WHITE ○ WARM WHITE ● RED ● BLUE ●  
GREEN ● PINK ● FOUR-COLOR ●

Model	Voltage	LED QTY	Length	LED	Power Source	Quantity
3AA	DC 4.5V	50	5m	SMD2025	Battery	80 PCS/CTN
	DC 4.5V	100	10m	SMD2025	Battery	60 PCS/CTN
USB	DC 4.5V	50	5m	SMD2025	USB	80 PCS/CTN
	DC 4.5V	100	10m	SMD2025	USB	60 PCS/CTN
SOL	DC 24V	100	12m	SMD2025	Solar	50 PCS/CTN
DC	DC 24V	100	10m	SMD2025	Adaptor	50 PCS/CTN

## RGB

Model	Voltage	LED QTY	Length	LED	Power Source	Quantity
BFRGB	DC 5V	50	5m	SMD2025	Battery	80 PCS/CTN
UFRGB	DC 5V	100	10m	SMD2025	USB	60 PCS/CTN
	DC 5V	200	20m	SMD2025	USB	40 PCS/CTN

## ACCESSORIES

ACCE	—	—	—	—	—	50 PCS/PACK
------	---	---	---	---	---	-------------



Ball



Star①



Star②



Snowflake



Butterfly



Dragonfly

# STAINLESS STEEL CABLE TIES



Specification	Thickness	Max bundle dia	Min.loop tensile	Quantity	Quantity	
				100 PCS/PACK pack/ctn	8 PCS/PACK pack/ctn	
ZD-5	100	—	23mm	—	100	1250
	150	—	37mm	—	100	625
	200	—	50mm	—	50	625
	250	—	63mm	—	50	625
	300	—	76mm	—	50	625
	350	—	89mm	—	50	625
	400	—	102mm	—	50	625
	450	—	115mm	—	50	625
	500	—	128mm	—	50	312
ZD-8	100	0.25mm	23mm	600N	50	625
	150	—	37mm	—	50	625
	200	—	50mm	—	50	312
	250	—	63mm	—	50	312
	300	—	76mm	—	50	312
	350	—	89mm	—	30	312
	400	—	102mm	—	25	315
	450	—	115mm	—	25	315
	500	—	128mm	—	25	315
ZD-12	500	—	—	—	15	210
	700	—	—	—	15	210
ZD-15	700	—	—	—	10	126

## ESS

EMT CONNECTOR SET SCREW TYPE ZINC DIE CASTING



Sizes	d1	L	Quantity
1/2"	18.50	29.00	1000/CTN
3/4"	24.00	33.30	500/CTN
1"	30.00	37.00	400/CTN
1-1/4"	38.80	48.00	200/CTN
1-1/2"	45.00	51.20	125/CTN
2"	56.40	60.00	100/CTN
2-1/2"	74.00	74.00	—
3"	90.00	85.00	—
4"	115.00	94.00	—

## ARC

ALUMINUM ROMEX CONNECTOR



Sizes	D1	D2	L	Quantity	
1/2"	0.47	0.23	0.21	11.2	500/CTN
3/4"	0.40	0.25	0.24	8.6	400/CTN
1"	0.47	0.28	0.21	9.5	250/CTN
1-1/4"	—	—	—	—	250/CTN
1-1/2"	—	—	—	—	100/CTN
2"	—	—	—	—	100/CTN

## ETC

EMT CONNECTOR COMPRESSION  
TYPE ZINC DIE CASTING



Sizes	D2	L	Quantity
1/2"	18.00	35.00	500/CTN
3/4"	24.00	35.00	500/CTN
1"	30.00	40.00	250/CTN
1-1/4"	39.00	45.00	100/CTN
1-1/2"	45.00	50.00	100/CTN
2"	56.50	55.00	50/CTN

## ETA

EMT COUPLING SET SCREW  
TYPE ALU



Sizes	Quantity
1/2"	500/CTN
3/4"	500/CTN
1"	400/CTN
1-1/4"	200/CTN
1-1/2"	125/CTN
2"	100/CTN
3"	—
4"	—

## CTK

EMT COUPLING SET SCREW  
TYPE STEEL



Sizes	D	D2	L	Quantity
1/2"	18.50	21.50	45.00	500/CTN
3/4"	24.00	27.00	63.00	250/CTN
1"	30.20	34.20	61.00	200/CTN
1-1/4"	39.00	43.00	72.00	100/CTN
1-1/2"	44.80	48.80	83.00	100/CTN
2"	56.50	60.50	95.00	50/CTN
2-1/2"	74.00	80.00	109.00	—
3"	90.50	96.50	114.00	20/CTN
4"	115.50	121.50	124.00	20/CTN

## ECC

EMT COUPLING  
COMPRESSION  
TYPE ZINC DIE CASTING



Sizes	D1	D2	L	Quantity
1/2"	16.00	18.00	40.00	500/CTN
3/4"	22.00	24.00	45.00	500/CTN
1"	27.00	30.00	50.00	250/CTN
1-1/4"	36.50	39.00	55.00	100/CTN
1-1/2"	41.50	45.00	60.00	100/CTN
2"	52.80	56.50	60.00	50/CTN

## ETO

EMT ONE HOLE METAL CLAMP  
MATERIAL: STEEL



Sizes	Quantity
1/2"	2000/CTN
3/4"	1000/CTN
1"	1000/CTN
1-1/4"	—
1-1/2"	—
2"	—

## ETT

EMT TWO HOLES METAL CLAMP  
MATERIAL: STEEL



Sizes	Quantity
1/2"	2000/CTN
3/4"	1000/CTN
1"	500/CTN
1-1/4"	—
1-1/2"	—
2"	—

## ICO

IMC ONE HOLE METAL CLAMP  
MATERIAL: STEEL



Sizes	Quantity
1/2"	1600/CTN
3/4"	1000/CTN
1"	1000/CTN
1-1/4"	500/CTN
1-1/2"	400/CTN
2"	300/CTN

## ICT

IMC TWO HOLES METAL CLAMP  
MATERIAL: STEEL



Sizes	Quantity
1/2"	1500/CTN
3/4"	1000/CTN
1"	500/CTN
1-1/4"	400/CTN
1-1/2"	400/CTN
2"	300/CTN
2 1/2"	150/CTN
3"	75/CTN
4"	50/CTN

## SCS

STRUT CLAMP  
MATERIAL: STEEL



Sizes	Quantity
1/2"	400 / CTN
3/4"	300 / CTN
1"	200 / CTN
1-1/4"	200 / CTN
1-1/2"	200 / CTN
2"	200 / CTN
3"	150 / CTN
4"	100 / CTN

## CHS

CONDUIT HANGER WITH BOLT  
MATERIAL: STEEL



Sizes	Quantity
1/2"	400 / CTN
3/4"	400 / CTN
1"	300 / CTN
1-1/4"	250 / CTN
1-1/2"	200 / CTN
2"	200 / CTN

## LNS

CONDUIT LOCKNUT  
MATERIAL: STEEL



Sizes	Quantity
1/2"	3000 / CTN
3/4"	3000 / CTN
1"	2000 / CTN
1-1/4"	1000 / CTN
1-1/2"	800 / CTN
2"	400 / CTN
3"	200 / CTN
4"	150 / CTN

## LH

LOOP HANGER  
MATERIAL: STEEL



Sizes	Quantity
1/2"	500 / CTN
3/4"	500 / CTN
1"	500 / CTN
1-1/4"	350 / CTN
1-1/2"	300 / CTN
2"	250 / CTN
3"	100 / CTN
4"	80 / CTN
6"	50 / CTN
8"	20 / CTN

## KG

CONDUIT COUPLING  
MATERIAL: STEEL



Sizes	Quantity
1/2"	500 / CTN
3/4"	150 / CTN
1"	200 / CTN
1-1/4"	150 / CTN
1-1/2"	120 / CTN
2"	80 / CTN
3"	30 / CTN
4"	20 / CTN

## IMC90

IMC CONDUIT ELBOW  
MATERIAL: STEEL  
WITH THREAD



Sizes	Quantity
1/2"	55 / CTN
3/4"	40 / CTN
1"	25 / CTN
1-1/4"	22 / CTN
1-1/2"	12 / CTN
2"	10 / CTN
3"	1 / PC
4"	1 / PC

## EMT90

EMT CONDUIT  
ELBOW 90° DEGREE



Sizes	Quantity
1/2"	180 / CTN
3/4"	90 / CTN
1"	50 / CTN
1-1/4"	30 / CTN
1-1/2"	20 / CTN
2"	10 / CTN
2-1/2"	—
3"	—
4"	—

U-CHANNEL GALVANIZED  
SHEET PLAN & SLOTTED



Sizes	Description
UC4121	41x21x1.5 mm x 3m
UC4141	41x41x1.5 mm x 3m

## DPJ

ZINC DIE CAST  
WATERPROOF CONNECTOR  
(MALE, HEXAGON)



Sizes	Quantity
1/2"	250 / CTN
3/4"	200 / CTN
1"	200 / CTN
1-1/4"	100 / CTN
1-1/2"	100 / CTN
2"	50 / CTN

## ICB

CONDUIT BUSHING ZINC



Sizes	Quantity
1/2"	1500 / CTN
3/4"	1000 / CTN
1"	500 / CTN
1-1/2"	300 / CTN
2"	160 / CTN
3"	100 / CTN
4"	100 / CTN

## EMT ELECTRICAL STEEL TUBING THIN TYPE



Sizes	Outside diameter	Inside diameter	Length
1/2"	17.93 mm (0.706 inch)	15.80 mm (0.622 inch)	3.00 m
3/4"	23.42 mm (0.922 inch)	20.93 mm (0.824 inch)	3.00 m
1"	29.54 mm (1.163 inch)	26.64 mm (1.049 inch)	3.00 m
1-1/4"	38.35 mm (1.510 inch)	38.05 mm (1.380 inch)	3.00 m
1-1/2"	44.20 mm (1.740 inch)	40.89 mm (1.610 inch)	3.00 m
2"	55.80 mm (2.197 inch)	52.50 mm (2.067 inch)	3.00 m

### Heavy-Duty Edition

Wall thickness
0.85 mm
1.00 mm
1.10 mm
1.30 mm
1.30 mm
1.40 mm

### Light- Duty Edition

Wall thickness
0.70 mm
0.75 mm
1.00 mm

## IMC TUBE WITH COUPLING



Sizes	Outside diameter	Length
1/2"	20.70 mm	3.05 m
3/4"	26.10 mm	3.05 m
1"	32.80 mm	3.05 m
1-1/4"	41.60 mm	3.05 m
1-1/2"	47.80 mm	3.05 m
2"	59.90 mm	3.05 m
3"	88.30 mm	3.05 m
4"	113.40 mm	3.05 m

### Heavy-Duty Edition

Wall thickness
1.98 mm
2.10 mm
2.35 mm
2.42 mm
2.50 mm
2.50 mm
3.30 mm
3.30 mm

### Light- Duty Edition

Wall thickness
1.79 mm
1.90 mm
2.10 mm
2.16 mm
2.20 mm
2.20 mm

## SES THREADED SERVICE ENTRANCE CAP



Sizes	A	B	C	Quantity
1/2"	68.07	66.55	50.80	125 / PCS
3/4"	96.52	69.09	60.20	100 / PCS
1"	84.33	78.99	66.55	100 / PCS
1-1/4"	113.28	81.28	76.20	100 / PCS
1-1/2"	123.19	110.24	84.07	50 / PCS
2"	168.15	138.18	117.35	30 / PCS
3"	322.00	140.00	208.00	1 / PC
4"	322.20	175.00	208.10	1 / PC

## SEC SERVICE ENTRANCE CAP WITH CLAMP

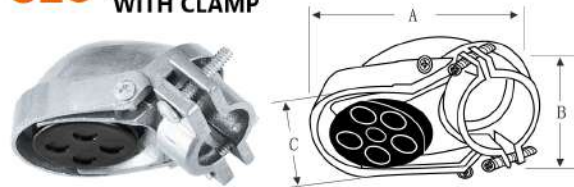

Sizes	A	B	C	Quantity
1/2"	74.42	66.55	50.80	125 / PCS
3/4"	82.55	69.85	60.20	100 / PCS
1"	88.90	82.55	66.55	100 / PCS
1-1/4"	114.30	82.55	76.20	100 / PCS
1-1/2"	139.70	120.65	84.07	50 / PCS
2"	171.45	152.40	117.35	30 / PCS
3"	322.00	140.00	208.00	1 / PC
4"	322.20	175.00	208.10	1 / PC

# PVC COATED CORRUGATED CONDUIT(JSH TYPE)



## JSC FLEXIBLE STEEL CONDUIT

Sizes	ID(MM)		OD(MM)		Bending radius(m)	Length/roll(m)
	MIN	MAX	MIN	MAX		
1/2"	15.80	16.20	20.20	20.70	65	30
3/4"	20.70	21.10	25.50	26.10	75	30
1"	26.20	26.80	31.60	32.20	100	30
1-1/4"	34.70	35.30	40.80	41.50	125	30
1-1/2"	40.00	40.70	46.60	47.20	150	30
2"	50.80	51.60	58.10	58.70	175	15



## JSH PVC COATED FLEXIBLE STEEL CONDUIT

Sizes	ID(MM)		OD(MM)		Bending radius(m)	Length/roll(m)
	MIN	MAX	MIN	MAX		
1/2"	15.80	16.20	20.20	20.70	65	30
3/4"	20.70	21.10	25.50	26.10	75	15
1"	26.20	26.80	31.60	32.20	100	15
1-1/4"	34.70	35.30	40.80	41.50	125	15
1-1/2"	40.00	40.70	46.60	47.20	150	15
2"	50.80	51.60	58.10	58.70	175	15



**MTB-U**  
METAL UTILITY BOX

Sizes	#16
Thickness	0.8mm
QTC/CTN	50 PCS



**MTB-J**  
METAL JUNCTION BOX

Sizes	#16
Thickness	0.8mm
QTC/CTN	50 PCS



**MTB-4**  
METAL SQUARE BOX 4X4

Sizes	#16
Thickness	0.8mm
QTC/CTN	50 PCS



**MTB-5**  
METAL SQUARE BOX 5X5

Sizes	#16
Thickness	1.2mm
QTC/CTN	40 PCS



**MTB-JC**  
METAL JUNCTION BOX

Sizes	#16
Thickness	1.0mm
QTC/CTN	100 PCS



**MTB-4C**  
METAL SQUARE COVER 4X4

Sizes	#16
Thickness	1.0mm
QTC/CTN	100 PCS



**MTB-5C**  
METAL SQUARE COVER 5X5

Sizes	#16
Thickness	1.0mm
QTC/CTN	100 PCS

# COPPER BOLT CLAMP

CBC-002

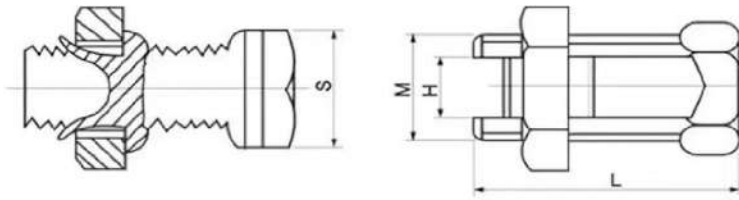

Description	Dimension(mm <sup>2</sup> )				Quantity
	L	H	H	S	
TJ-16	26	11	5	12	20 PACK
TJ-25	27	13	7	14	20 PACK
TJ-35	35	17	8	18	20 PACK
TJ50-70	42	22	11.5	24	10 PACK
T90-120	44	25	14	25	10 PACK
TJ150-185	55	28	18	30	6 PACK
TJ200-240	56	30	19	32	6 PACK

# INSULATED BUTT CONNECTOR

IBC-011

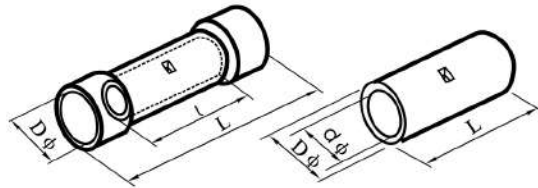

Description		Cnle sq		Dimension			Imax	Quantity
Model	Color	A.W.G	mm <sup>2</sup>	l(mm)	Dφ(mm)	L(mm)		
BV1.25	Red	22-16	0.5-1.5	15.0	1.7	26.0	19A	240 PACK/CTN
BV2	Blue	16-14	1.5-2.5	15.0	2.3	26.0	27A	192 PACK/CTN
BV5.5	Yellow	12-10	4-6	15.0	3.4	26.0	48A	120 PACK/CTN

# INSULATED FEMALE DISCONNECT

IFD-013

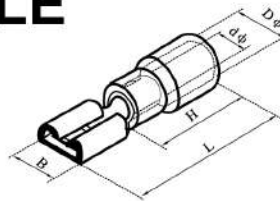

CONDUCTOR SECTION: 0.5~1.5mm<sup>2</sup>(22~16), MAXIMUM CURRENT: Imax=10A

Description		Mema tab	Thickness of material	Dimension					Quantity
Model	Color			B(mm)	dφ(mm)	Dφ(mm)	L(mm)	H(mm)	
FDD1.25-250	Red	0.8x6.35mm	0.40mm	7.4	1.7	3.8	21.0	10.0	360 PACK/CTN

CONDUCTOR SECTION: 1.5~2.5mm<sup>2</sup>(16~14), MAXIMUM CURRENT: Imax=15A

Description		Mema tab	Thickness of material	Dimension					Quantity
Model	Color			B(mm)	dφ(mm)	Dφ(mm)	L(mm)	H(mm)	
FDD2-250	Blue	0.8x6.35mm	0.40mm	7.4	2.3	4.3	21.0	10.0	360 PACK/CTN

CONDUCTOR SECTION: 4~6mm<sup>2</sup>(12~10), MAXIMUM CURRENT: Imax=24A

Description		Mema tab	Thickness of material	Dimension					Quantity
Model	Color			B(mm)	dφ(mm)	Dφ(mm)	L(mm)	H(mm)	
FDD5.5-250	Yellow	0.5x6.35mm	0.40mm	7.4	3.4	5.7	25.0	14.0	240 PACK/CTN

METAL ACCS. / WIRE

# INSULATED MALE DISCONNECT

IMD-015

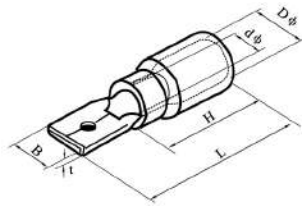

CONDUCTOR SECTION: 0.5~1.5mm<sup>2</sup>(22~16), MAXIMUM CURRENT: I<sub>max</sub>=10A

Description		Mema tab	Thickness of material	Dimension					Quantity
Model	Color			B(mm)	dΦ(mm)	DΦ(mm)	L(mm)	H(mm)	
MDD1.25-250	Red	0.8x6.35mm	0.40mm	6.35	1.7	4.3	21.0	10.0	480 PACK/CTN

CONDUCTOR SECTION: 1.5~2.5mm<sup>2</sup>(16~14), MAXIMUM CURRENT: I<sub>max</sub>=15A

Description		Mema tab	Thickness of material	Dimension					Quantity
Model	Color			B(mm)	dΦ(mm)	DΦ(mm)	L(mm)	H(mm)	
MDD2-250	Blue	0.5x6.35mm	0.40mm	6.35	2.3	4.3	21.0	10.0	480 PACK/CTN

CONDUCTOR SECTION: 4~6mm<sup>2</sup>(12-10), MAXIMUM CURRENT: I<sub>max</sub>=24A

Description		Mema tab	Thickness of material	Dimension					Quantity
Model	Color			B(mm)	dΦ(mm)	DΦ(mm)	L(mm)	H(mm)	
MDD5.5-250	Yellow	0.8x6.35mm	0.40mm	6.35	3.4	5.7	25.0	14.0	240 PACK/CTN

# INSULATED RING TERMINAL

IRT-016

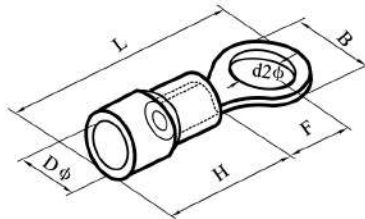

CONDUCTOR SECTION: 1.5~2.5mm<sup>2</sup>(16-14), MAXIMUM CURRENT: I<sub>max</sub>=27A

Description		American bolt		Dimension					Quantity
Model	Color	Number	Diameter(mm)	B(mm)	L(mm)	F(mm)	H(mm)	DΦ(mm)	
RVS2-5	Blue	#10	5.3	8.5	22.5	7.75	10.0	4.9	360 PACK/CTN

CONDUCTOR SECTION: 4~6mm<sup>2</sup>(12-10), MAXIMUM CURRENT: I<sub>max</sub>=48A

Description		American bolt		Dimension					Quantity
Model	Color	Number	Diameter(mm)	B(mm)	L(mm)	F(mm)	H(mm)	DΦ(mm)	
RV5.5-5	Yellow	#10	5.3	9.5	25.5	8.3	12.5	6.7	144 PACK/CTN
RV5.5-8	Yellow	5/16	8.4	15.0	33.7	13.7	12.5	6.7	144 PACK/CTN

# HEAT SHRINK TUBING DRS

## Function

- Material: EXA
- Wire coat and insulation
- Make the joint of terminal block and wire insulated
- Divide the colors
- Water-proof
- Protection and insulation of resistors and electrical capacitors

## Standard color

- Black, white, red, blue, yellow, green, brown, grey, orange and purple

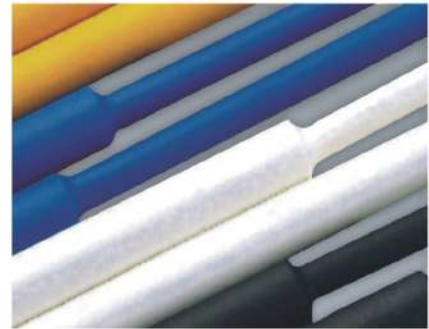

Description		As supplied		Dimension		Quantity
Model	Color	I.D(mm)	Thickness(mm)	I.D(mm)	Thickness(mm)	
DRS-5	Red	5.0	0.35±0.05	2.5	0.55±0.10	100 m/roll
DRS-8	Yellow	8.0	0.35±0.05	4.0	0.55±0.10	100 m/roll
DRS-12	Green	12.0	0.35±0.10	6.0	0.70±0.10	100 m/roll
DRS-20	Blue	20.0	0.50±0.10	10.0	0.90±0.10	100 m/roll

Description		As supplied		Dimension		Quantity
Model	Color	I.D(mm)	Thickness(mm)	I.D(mm)	Thickness(mm)	
DRS-30	Black	30.0	0.50±0.10	15.0	1.00±0.20	25 m/roll

# HEAT SHRINK TUBING

## Function

- Material: EXA
- Wire coat and insulation
- Make the joint of terminal block and wire insulated
- Divide the colors
- Water-proof
- Protection and insulation of resistors and electrical capacitors



## HST-100C

Size(mm)	DRS-1.5	DRS-2.5	DRS-4.0	DRS-6.0	DRS-10.0	DRS-13.0
Color	Black ●	Yellow ●	Red ●	Green ●	Blue ●	White ○
L(cm)	10cm * 30pcs	10cm * 30pcs	10cm * 20pcs	10cm * 10pcs	10cm * 6 pcs	10cm * 4 pcs

## HST-100B

Size(mm)	DRS-1.5	DRS-2.5	DRS-4.0	DRS-6.0	DRS-10.0	DRS-13.0
Color	Black ●	Black ●	Black ●	Black ●	Black ●	Black ●
L(cm)	10cm * 30pcs	10cm * 30pcs	10cm * 20pcs	10cm * 10pcs	10cm * 6 pcs	10cm * 4 pcs

# WIRES & CABLES

## FLAT CORD (SPEAKER WIRE)

99.99%  
pure  
copper

PVC INSULATED  
FLEXIBLE CORD  
STRANDED



Description	Gauge	Code	Meter / Roll	Withstand temperature	Maximum voltage	Color
SPT-1	22/2 Gauge	0.30mm <sup>2</sup> /2C #22	150 MTRS/ROLL	60°C	600 Volts	Black / White
SPT-1	18/2 Gauge	0.75mm <sup>2</sup> /2C #18	150 MTRS/ROLL	60°C	600 Volts	Black / White
SPT-2	16/2 Gauge	1.25mm <sup>2</sup> /2C #16	150 MTRS/ROLL	60°C	600 Volts	Black / White
SPT-3	14/2 Gauge	2.00mm <sup>2</sup> /2C #14	150 MTRS/ROLL	60°C	600 Volts	Black / White

## THHN-TWHN

99.99%  
pure  
copper

Thermoplastic Insulated  
Electric Wires and cables  
STRANDED WIRE

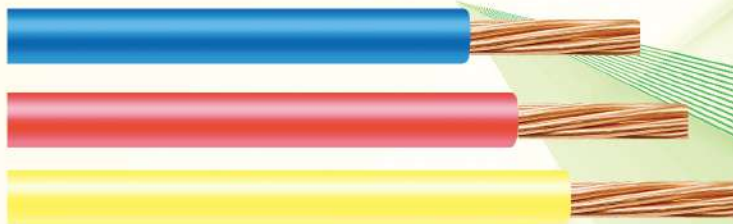

Description	Gauge	Code	Withstand temperature	Maximum voltage	Color	150 M/roll	500 M/roll
THHN-TWHN	14/7 Gauge	2.0mm <sup>2</sup> #14	90°C	600 Volts			
THHN-TWHN	12/7 Gauge	3.5mm <sup>2</sup> #12	90°C	600 Volts	Blue / Green /		
THHN-TWHN	10/7 Gauge	5.5mm <sup>2</sup> #10	90°C	600 Volts	White / Red /		
THHN-TWHN	8/7 Gauge	8.0mm <sup>2</sup> #8	90°C	600 Volts	Yellow / Black		
THHN-TWHN	6/7 Gauge	14.0mm <sup>2</sup> #6	90°C	600 Volts			

## NM WIRE

99.99%  
pure  
copper

Non- Metallic Flat  
Jacketed Electric Wires  
SINGLE CORE



Description	Gauge	Code	Meter / Roll	Withstand temperature	Maximum voltage	Color
14/2 NM	14/2 Gauge	1.6mm <sup>2</sup> /2C #14/2	75 MTRS/ROLL	60°C	600 Volts	Black / White
12/2 NM	12/2 Gauge	2.0mm <sup>2</sup> /2C #12/2	75 MTRS/ROLL	60°C	600 Volts	Black / White
10/2 NM	10/2 Gauge	2.6mm <sup>2</sup> /2C #12/2	75 MTRS/ROLL	60°C	600 Volts	Black / White

METAL ACS. /  
WIRE

OPPO | ROTO